



Industrial Hose Technical Data Sheets

Be More

FLEXIBLE

2025/26 Technical Data Sheets



flexCHEM™





flexCHEM™ 220 (220 RS)

Heavy-duty abrasion resistant chemical suction and discharge hose

An ideal solution for demanding environments. Lightweight and flexible, its SBR rubber blend with static carbon black ensures abrasion resistance and static dissipation. Perfect for construction dewatering, liquid waste, cesspool cleaning, septic handling, agricultural applications, and marine use. The smooth bore allows for precise flow without interruptions.

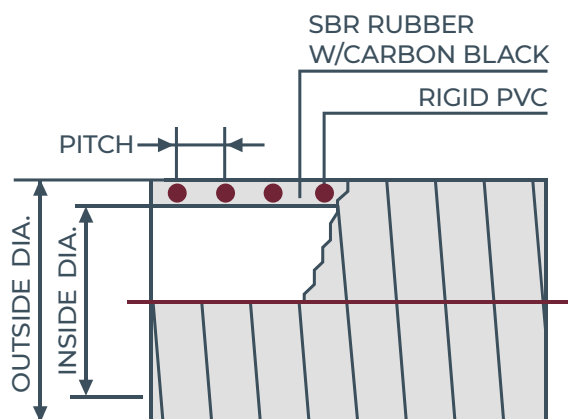

FEATURES

The lightweight and flexible SBR rubber hose blended with static carbon black makes it abrasion resistant. Static dissipating with no grounding wire. The smooth bore allows for precise flow because no irregularities in the wall can cause interruptions.

APPLICATIONS

Heavy-duty chemical liquid suction hose for use in construction dewatering, liquid waste, cesspool cleaning, septic handling, agricultural applications and marine use.

TEMP. RANGE

-40°F to 140°F

CONSTRUCTION

SBR rubber with static carbon black, rigid PVC helix, smooth bore, smooth O.D.

AVAILABLE SIZES

ID (inches)	OD (inches)	Pitch (inches)	Minimum Bend Radius (72°F, inches)	Working Pressure (72°F, PSI)	Vacuum Rating (72°F, In Hg)	Weight (Lbs/Ft)	Standard Length (Ft)
1-1/2	1.85	0.35	3.0	50	29.8	0.50	100
2	2.40	0.39	4.0	50	29.8	0.74	100
2-1/2	2.99	0.56	5.0	50	29.8	1.01	100
3	3.50	0.59	6.0	43	29.8	1.30	100
4	4.57	0.65	9.0	38	29.8	2.01	100
6	6.69	0.87	15.0	23	28.0	3.37	60, 100

Over flexing or repeated flexing of hose within 18" of fitting is a common cause of hose failure. Installing a 12"-14" section of our Banding Coil at the end of the hose should be considered. *Kanaflex will not be responsible for damage to hose due to over flexing.*



flexCHEM™ 300 (300 GR/EPDM)

All purpose chemical suction and discharge hose

A versatile solution for challenging environments. Lightweight and flexible, resistant to most agricultural chemicals, with an external helix for easy drag. Ideal for construction dewatering, liquid waste, cesspool cleaning, septic handling, agricultural applications, and marine use. The smooth bore ensures precise flow.

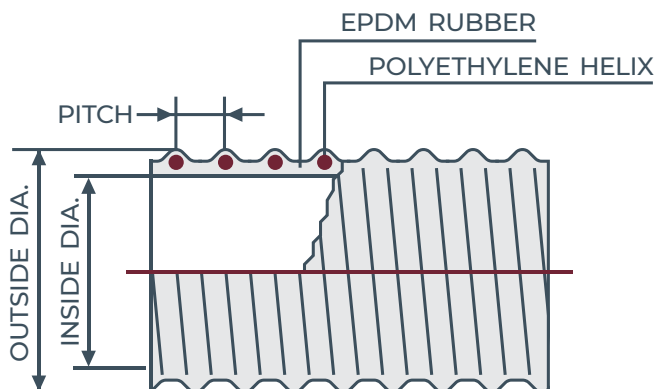

FEATURES

Lightweight and flexible, this hose is resistant to most agricultural chemicals. External helix provides for easy drag. The smooth bore allows for precise flow because no irregularities in the wall can cause interruptions.

APPLICATIONS

Heavy-duty liquid suction hose for use in construction dewatering, liquid waste, cesspool cleaning, septic handling, agricultural applications and marine use.

TEMP. RANGE

-40°F to 140°F

CONSTRUCTION

EPDM rubber, polyethylene helix, smooth bore, corrugated O.D.

NOTE

Hose available with red, blue, yellow, and black helix with 500 ft. minimum order.

AVAILABLE SIZES

ID (inches)	OD (inches)	Pitch (inches)	Minimum Bend Radius (72°F, inches)	Working Pressure (72°F, PSI)	Vacuum Rating (72°F, In Hg)	Weight (Lbs/Ft)	Standard Length (Ft)
1	1.34	0.30	1.9	50	29.8	0.23	100
1-1/4	1.7	0.33	3.2	50	29.8	0.34	100
1-1/2	2.0	0.35	3.2	50	29.8	0.40	100
2	2.5	0.39	5.2	50	29.8	0.67	100
2-1/2	3.1	0.56	5.6	50	29.8	0.92	100
3	3.6	0.59	7.1	43	29.8	1.10	100
4	4.7	0.65	11.0	38	29.8	1.84	100
6	6.9	0.87	20.0	23	28.0	3.07	60, 100

Over flexing or repeated flexing of hose within 18" of fitting is a common cause of hose failure. Installing a 12"-14" section of our Banding Coil at the end of the hose should be considered. *Kanaflex will not be responsible for damage to hose due to over flexing.*



flexCHEM™ 390 (390 SD)

Heavy-duty reinforced chemical suction and discharge hose

Combining flexibility and durability. With synthetic braiding for increased flexibility and abrasion resistance, it's rated for both suction and discharge. Resistant to agricultural chemicals, ideal for construction applications, and suitable for liquids such as agricultural chemicals, liquid fertilizers, and dewatering.

FEATURES

The lightweight hose comes with synthetic braiding that provides increased flexibility and abrasion resistance. Rated for both suction and discharge. External helix provides for easy drag. Resistant to agricultural chemicals and durable in construction applications. The smooth bore allows for precise flow because no irregularities in the wall can cause interruptions.

APPLICATIONS

Suction and discharge of liquids in the construction, and agricultural industries such as agricultural chemicals, liquid fertilizers, and dewatering

TEMP. RANGE

-40°F to 140°F

CONSTRUCTION

EPDM rubber, polyethylene helix, synthetic braiding, smooth bore, corrugated O.D.

ACCESSORIES

Banding coil, Powerlock clamp

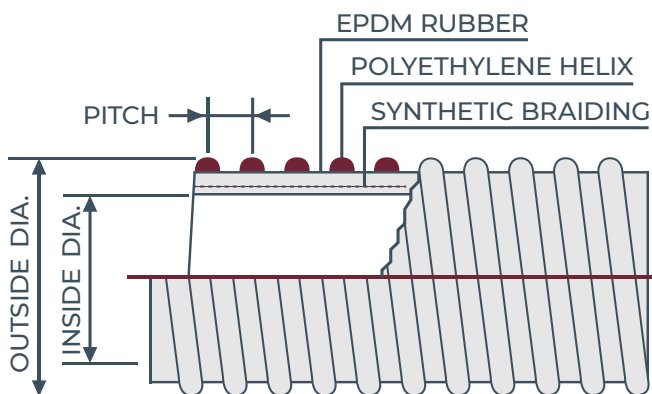

AVAILABLE SIZES

ID (inches)	OD (inches)	Pitch (inches)	Minimum Bend Radius (72°F, inches)	Working Pressure (72°F, PSI)	Vacuum Rating (72°F, In Hg)	Weight (Lbs/Ft)	Standard Length (Ft)
1-1/4	1.8	0.39	3.0	100	29.8	0.45	60, 100
1-1/2	2.1	0.43	3.0	100	29.8	0.50	60, 100
2	2.6	0.47	5.0	100	29.8	0.73	60, 100
3	3.7	0.59	7.0	90	29.8	1.25	60, 100

Over flexing or repeated flexing of hose within 18" of fitting is a common cause of hose failure. Installing a 12"-14" section of our Banding Coil at the end of the hose should be considered. *Kanaflex will not be responsible for damage to hose due to over flexing.*

flexDUCT™





flexDUCT™ 150 (150 CL)

Lightweight blower and ducting hose

A versatile solution for light-duty applications. Flexible and lightweight, it features an external helix for easy drag and a smooth bore for precise flow. Ideal for general ducting needs, including ventilation, handling grass clippings, leaves, dust, and fumes.

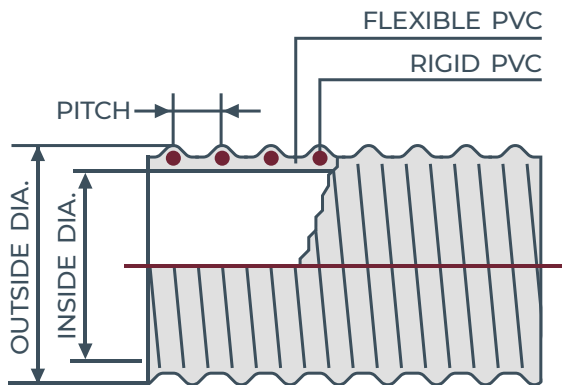

FEATURES

Flexible and lightweight. External helix provides easy drag. The smooth bore allows for precise flow because no irregularities in the wall can cause interruptions.

APPLICATIONS

Light-duty general ducting for ventilation and grass clippings, leaves, dust and fumes.

CONSTRUCTION

Flexible PVC, rigid PVC helix, smooth bore, corrugated O.D.

TEMP. RANGE

-13°F to 140°F

NOTE

Not a food-grade hose

AVAILABLE SIZES

ID (inches)	OD (inches)	Pitch (inches)	Minimum Bend Radius (72°F, inches)	Working Pressure (72°F, PSI)	Vacuum Rating (72°F, in Hg)	Weight (Lbs/Ft)	Standard Length (Ft)
2-1/2	2.81	0.55	2.5	6	—	0.37	50,100
3	3.37	0.59	3.0	6	—	0.54	50,100
4	4.41	0.61	4.0	5	—	0.71	50,100
5	5.55	0.80	5.0	3	—	1.00	50,100
6	6.51	0.80	6.0	3	—	1.29	50,100
7	7.54	0.85	7.0	2	—	1.38	50,100
8	8.55	0.85	8.0	2	—	1.71	50

Over flexing or repeated flexing of hose within 18" of fitting is a common cause of hose failure. Installing a 12"-14" section of our Banding Coil at the end of the hose should be considered. *Kanaflex will not be responsible for damage to hose due to over flexing.*



flexDUCT™ 155 (155 GY)

Heavy-duty blower and ducting hose

A reliable solution for the collection of grass, leaves, dust, and fumes. Clear sidewall for visual inspection, smooth bore for precise flow, and easy drag with an external helix.

FEATURES

Clear sidewall permits visual check of material flow. The smooth bore allows for precise flow because no irregularities in the wall can cause interruptions. Smooth bore also promotes drainability. External helix provides for easy drag.

APPLICATIONS

Heavy-duty blower and ducting hose for collection of grass, leaves, dust, and fumes

CONSTRUCTION

Flexible PVC, rigid PVC helix, smooth bore, corrugated O.D.

TEMP. RANGE

-13°F to 140°F

NOTE

Not a food-grade hose

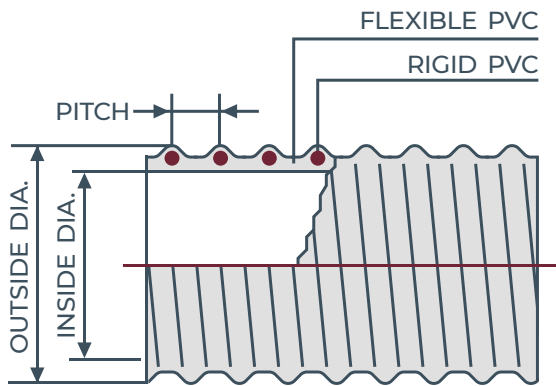

AVAILABLE SIZES

ID (inches)	OD (inches)	Pitch (inches)	Minimum Bend Radius (72°F, inches)	Working Pressure (72°F, PSI)	Vacuum Rating (72°F, In Hg)	Weight (Lbs/Ft)	Standard Length (Ft)
1-1/2	1.79	0.35	1.5	20	20.0	0.26	100
2	2.31	0.39	2.5	15	18.0	0.39	100
2-1/2	2.85	0.54	3.0	15	15.0	0.44	100
3	3.39	0.56	3.5	15	15.0	0.70	100
4	4.60	0.65	4.5	15	15.0	1.43	100
5	5.52	0.87	8.8	12	12.0	1.87	100
6	6.52	0.87	9.0	11	10.0	2.32	100
8	8.85	0.91	14.0	10	9.0	4.03	100

Over flexing or repeated flexing of hose within 18" of fitting is a common cause of hose failure. Installing a 12"-14" section of our Banding Coil at the end of the hose should be considered. *Kanaflex will not be responsible for damage to hose due to over flexing.*



flexDUCT™ 620 (620 WD)

General ducting and blower hose

A versatile solution rated to 220°F. Combining abrasion resistance with flexibility, it's ideal for lightweight abrasives like sawdust, grass clippings, street refuse, and cotton pickers. Constructed with EPDM rubber, a metal wire helix, a smooth bore, and a slightly corrugated outer diameter.

FEATURES

Rated to 220°F. Abrasion resistant yet very flexible. 100% rubber sidewall (no fabric).

APPLICATIONS

For use with lightweight abrasives such as sawdust, grass clippings, street refuse and cotton pickers.

CONSTRUCTION

EPDM rubber, metal wire helix, smooth bore, slightly corrugated O.D.

TEMP. RANGE

-40°F to 220°F

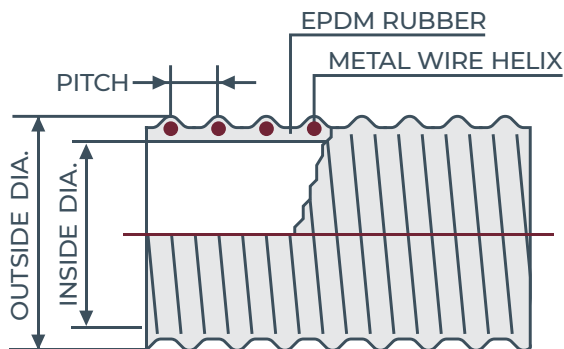

AVAILABLE SIZES

ID (inches)	OD (inches)	Pitch (inches)	Minimum Bend Radius (72°F, inches)	Working Pressure (72°F, PSI)	Vacuum Rating (72°F, In Hg)	Weight (Lbs/Ft)	Standard Length (Ft)
2	2.36	0.43	2.0	12	12.0	0.40	50
2-1/2	3.00	0.58	3.0	12	9.0	0.44	50
3	3.37	0.60	3.0	12	8.0	0.55	50
4	4.39	0.65	4.0	9	6.0	0.73	50
5	5.43	0.88	5.0	7	5.0	0.84	50
6	6.36	0.87	6.0	6	4.0	1.04	50
7	7.32	0.89	7.0	5	4.0	1.17	50
8	8.35	0.92	8.0	4	4.0	1.38	50
10	10.45	1.02	10.0	3	4.0	2.40	50
12	12.40	1.20	12.0	3	4.0	2.50	50

Over flexing or repeated flexing of hose within 18" of fitting is a common cause of hose failure. Installing a 12"-14" section of our Banding Coil at the end of the hose should be considered. *Kanaflex will not be responsible for damage to hose due to over flexing.*



flexDUCT™ 625 (625 WD WS)

General ducting and blower hose

A versatile solution with a wear strip for light dragging. Combining abrasion resistance with flexibility, it's ideal for lightweight abrasives like sawdust, grass clippings, street refuse, and cotton pickers. Constructed with EPDM rubber, a metal wire helix, a smooth bore, and a slightly corrugated outer diameter.

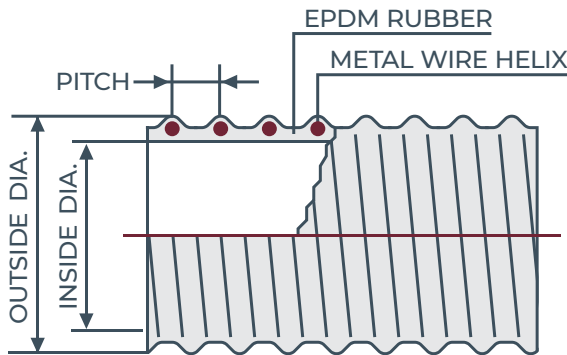

FEATURES

Abrasion resistant yet very flexible. 100% rubber sidewall (no fabric). Also, comes with an outer metal wear strip for light dragging. External helix provides easy drag. The smooth bore allows for precise flow because no irregularities in the wall can cause interruptions.

APPLICATIONS

For use with lightweight abrasives such as sawdust, grass clippings, street refuse and cotton pickers.

CONSTRUCTION

EPDM rubber, metal wire helix, metal wear strip, smooth bore, slightly corrugated O.D.

TEMP. RANGE

-40°F to 220°F

AVAILABLE SIZES

ID (inches)	OD (inches)	Pitch (inches)	Minimum Bend Radius (72°F, inches)	Working Pressure (72°F, PSI)	Vacuum Rating (72°F, In Hg)	Weight (Lbs/Ft)	Standard Length (Ft)
2-1/2	3.11	0.58	3.0	12	9.0	0.48	50
3	3.48	0.60	3.0	12	8.0	0.61	50
4	4.57	0.65	4.0	9	6.0	0.85	50
5	5.61	0.88	5.0	7	5.0	0.90	50
6	6.54	0.87	6.0	6	4.0	1.17	50
7	7.48	0.89	7.0	5	4.0	1.27	50
8	8.54	0.92	8.0	4	4.0	1.50	50
10	10.69	1.02	10.0	3	4.0	2.67	50
12	12.60	1.20	12.0	3	4.0	2.80	25

Over flexing or repeated flexing of hose within 18" of fitting is a common cause of hose failure. Installing a 12"-14" section of our Banding Coil at the end of the hose should be considered. *Kanaflex will not be responsible for damage to hose due to over flexing.*



flexDUCT™ 630 (630 ED)

Medium-duty ducting and blower hose

A durable solution with a thicker sidewall for enhanced abrasion resistance. Designed for medium-duty blower and ducting applications, including hay baling, street refuse, grain dust, cotton pickers, wood chips, straw blowing, and leaf and grass collection. Constructed with EPDM rubber, a polypropylene helix.

FEATURES

Thicker sidewall for more abrasion resistance. External helix acts as a scuff guard. 100% rubber sidewall (no fabric).

APPLICATIONS

Medium-duty blower and ducting applications such as hay baling, street refuse, grain dust, cotton pickers, wood chips, straw blowing, leaf and grass collection.

CONSTRUCTION

EPDM rubber, polypropylene helix, smooth bore, corrugated O.D.

TEMP. RANGE

-40°F to 158°F

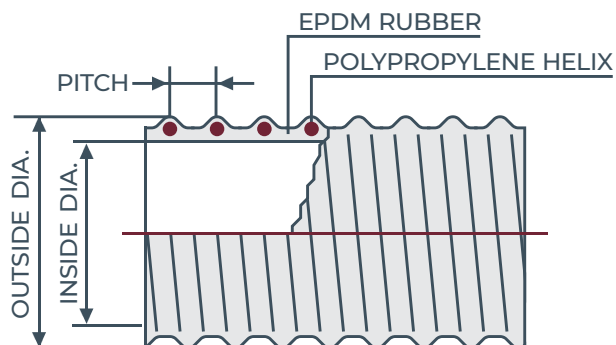

AVAILABLE SIZES

ID (inches)	OD (inches)	Pitch (inches)	Minimum Bend Radius (72°F, inches)	Working Pressure (72°F, PSI)	Vacuum Rating (72°F, in Hg)	Weight (Lbs/Ft)	Standard Length (Ft)
4	4.53	0.67	4.0	—	—	0.70	50
6	6.56	0.83	6.0	—	—	1.05	50
8	8.66	0.87	8.0	—	—	1.46	50

Over flexing or repeated flexing of hose within 18" of fitting is a common cause of hose failure. Installing a 12"-14" section of our Banding Coil at the end of the hose should be considered. *Kanaflex will not be responsible for damage to hose due to over flexing.*



flexDUCT™ 660 (660 YD)

Heavy-duty duct hose

An exceptional solution for demanding applications. With a smooth bore for higher laminar flow, a robust “safety yellow” helix for visibility and abrasion resistance, it’s perfect for heavy-duty ducting needs like cleaning, grass and leaf collection, cement dust recovery, blast cabinet dust collection systems, and grain auger downspouts. Constructed with EPDM rubber, and a polypropylene helix.

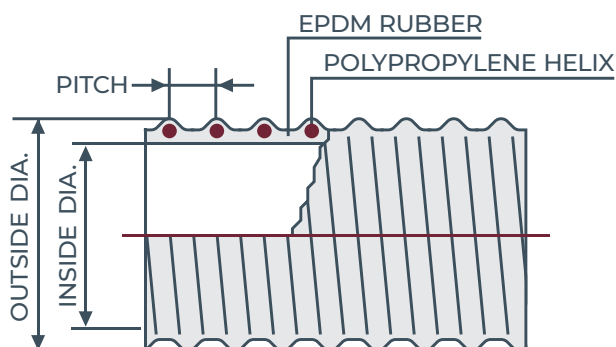

FEATURES

Smooth bore for higher laminar flow. Extra heavy-duty “safety yellow” helix for high visibility and superior external abrasion resistance for “dragging” applications. 100% rubber sidewall (no fabric).

APPLICATIONS

Heavy-duty ducting applications such as duct cleaning, commercial grass and leaf collection, cement dust recovery for floor finishing, blast cabinet dust collection systems, and grain auger downspouts

CONSTRUCTION

EPDM rubber, polypropylene helix, smooth bore, corrugated O.D.

TEMP. RANGE

-40°F to 158°F

AVAILABLE SIZES

ID (inches)	OD (inches)	Pitch (inches)	Minimum Bend Radius (72°F, inches)	Working Pressure (72°F, PSI)	Vacuum Rating (72°F, In Hg)	Weight (Lbs/Ft)	Standard Length (Ft)
4	4.57	0.67	4.0	9	6.0	0.79	50
5	5.53	0.87	5.0	7	5.0	0.83	50
6	6.57	0.82	6.0	6	4.0	1.26	50
8	8.72	0.83	8.0	4	4.0	1.92	50
10	10.83	1.06	10.0	4	4.0	2.38	25
12	12.73	1.18	12.0	3	3.0	2.65	25

Over flexing or repeated flexing of hose within 18" of fitting is a common cause of hose failure. Installing a 12"-14" section of our Banding Coil at the end of the hose should be considered. *Kanaflex will not be responsible for damage to hose due to over flexing.*



flexDUCT™ P (KNDT)

Polypropylene general ducting and blower hose

A versatile solution with interlock construction for adjustable inside diameter. Ideal for general ducting, spot coolers, clean room venting, and fume/dust removal, as well as elbows for rigid pipe.

FEATURES

Interlock construction allows the inside diameter to be changed by twisting the hose, while still holding its shape.

APPLICATIONS

General ducting and blower hose used for spot coolers, clean room venting, fume/dust removal, elbows for rigid pipe

CONSTRUCTION

Interlocked polypropylene

TEMP. RANGE

-13°F to 180°F

NOTE

Not a food grade hose.

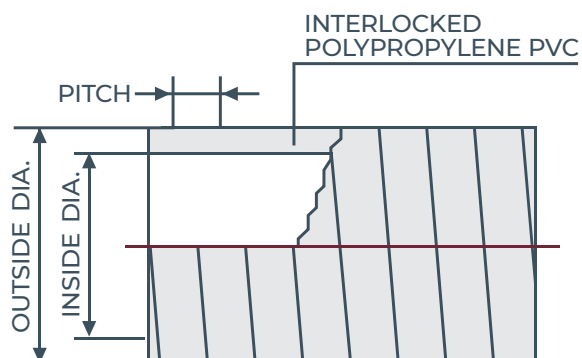

AVAILABLE SIZES

ID (inches)	OD (inches)	Pitch (inches)	Minimum Bend Radius (72°F, inches)	Working Pressure (72°F, PSI)	Vacuum Rating (72°F, in Hg)	Weight (Lbs/Ft)	Standard Length (Ft)
2-1/2	2.80	—	6.0	—	—	0.35	20
3	3.23	—	7.0	—	—	0.36	20
4	4.20	—	11.0	—	—	0.52	20
5	5.20	—	14.0	—	—	0.76	20
6	6.16	—	15.0	—	—	0.79	20
8	8.06	—	20.0	—	—	1.07	20
10	10.21	—	27.0	—	—	1.52	10
12	12.07	—	32.0	—	—	1.68	10



flexDUCT™ U 150 (150 UDH)

Medium-duty polyurethane blower and ducting hose

A versatile solution for medium-duty applications. Lightweight, flexible, and abrasion-resistant, it is designed for various ducting and blower needs.

FEATURES

Lightweight and flexible. External helix provides for easy drag. Abrasion-resistant polyurethane and smooth bore eliminate material build-up.

APPLICATIONS

Medium-duty ducting and blower applications. For use with light to medium weight abrasives, leaf and grass collection, cotton pickers, mulch blowing, dust and sawdust collection.

CONSTRUCTION

Flexible clear polyurethane, rigid PVC helix, smooth bore, corrugated O.D.

TEMP. RANGE

-40°F to 140°F

NOTE

Not a food-grade hose

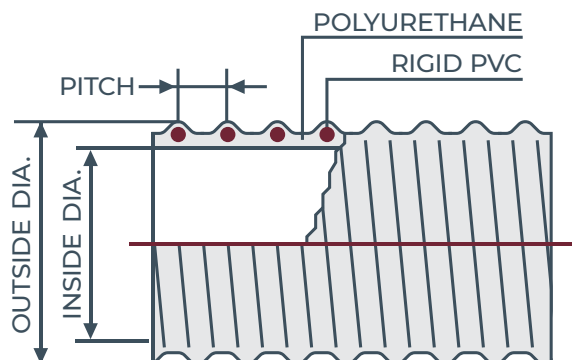

AVAILABLE SIZES

ID (inches)	OD (inches)	Pitch (inches)	Minimum Bend Radius (72°F, inches)	Working Pressure (72°F, PSI)	Vacuum Rating (72°F, in Hg)	Weight (Lbs/Ft)	Standard Length (Ft)
2-1/2	2.89	0.53	2.5	9	16.0	0.34	50
3	3.46	0.57	3.0	8	15.0	0.48	50
4	4.46	0.59	4.0	7	12.0	0.70	50
5	5.57	0.83	5.0	6	9.0	1.10	50
6	6.56	0.83	6.0	5	7.0	1.30	50
7	7.59	0.85	7.0	4	6.0	1.56	50
8	8.59	0.85	8.0	3	5.0	1.65	50

Over flexing or repeated flexing of hose within 18" of fitting is a common cause of hose failure. Installing a 12"-14" section of our Banding Coil at the end of the hose should be considered. *Kanaflex will not be responsible for damage to hose due to over flexing.*



flexDUCT™ U 520 (520U)

Lightweight blower and ducting hose

A lightweight, abrasion-resistant ducting solution. The flexDUCT™ U 520 features a multi-directional, kink-resistant design with a copper-coated steel wire helix for static safety. Ideal for dust collection, vapor recovery, and woodworking, it performs reliably in temperatures from -60°F to 200°F.

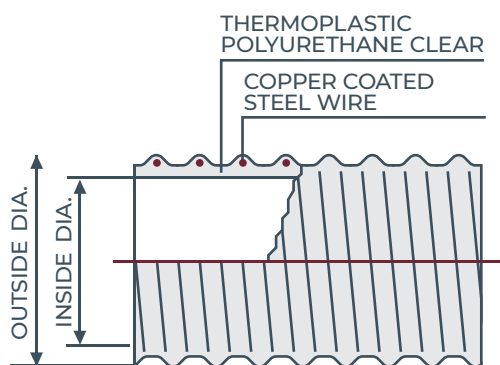

FEATURES

The multi-directional design allows the hose to flex in multiple directions without kinking or collapsing, making it ideal for dynamic environments where hoses must navigate around obstacles or move with equipment. For safety against static, the hose is also equipped with a copper coded steel wire helix.

APPLICATIONS

This product is specifically designed for applications requiring high abrasion resistance, including dust collection, vapor recovery, and woodworking.

CONSTRUCTION

Flexible clear polyurethane, copper coded steel wire helix, smooth bore, corrugated O.D., bi-directional design.

TEMP. RANGE

-60 °F to 200 °F

AVAILABLE SIZES

ID (inches)	OD (inches)	Minimum Bend Radius (72°F, inches)	Working Pressure (72°F, PSI)	Vacuum Rating (72°F, In Hg)	Weight (Lbs/Ft)	Standard Length (Ft)
3	3.270	3.5	30	29	0.40	25,50
4	4.330	3.5	20	24	0.50	25,50
5	5.330	4.5	18	15	0.55	25,50
6	6.340	5.5	15	11	0.89	25,50
7	7.360	5.5	13	10	0.96	25,50
8	8.460	6.5	10	11	1.14	25,50
10	10.560	7.5	7	5	1.40	25,50
12	12.600	10.0	6	3	1.68	25,50

Over flexing or repeated flexing of hose within 18" of fitting is a common cause of hose failure. Installing a 12"-14" section of our Banding Coil at the end of the hose should be considered. *Kanaflex will not be responsible for damage to hose due to over flexing.*



flexDUCT™ U 535 (535U)

Middleweight blower and ducting hose

A middleweight, abrasion-resistant ducting solution. The flexDUCT™ U 535 features a multi-directional, kink-resistant design with a copper-coated steel wire helix for static safety. Ideal for dust collection, vapor recovery, and woodworking, it performs reliably in temperatures from -60°F to 200°F.

FEATURES

The multi-directional design allows the hose to flex in multiple directions without kinking or collapsing, making it ideal for dynamic environments where hoses must navigate around obstacles or move with equipment. For safety against static, the hose is also equipped with a copper coded steel wire helix.

APPLICATIONS

This product is specifically designed for applications requiring high abrasion resistance, including dust collection, vapor recovery, and woodworking.

CONSTRUCTION

Flexible clear polyurethane, copper coded steel wire helix, smooth bore, corrugated O.D., bi-directional design.

TEMP. RANGE

-60 °F to 200 °F

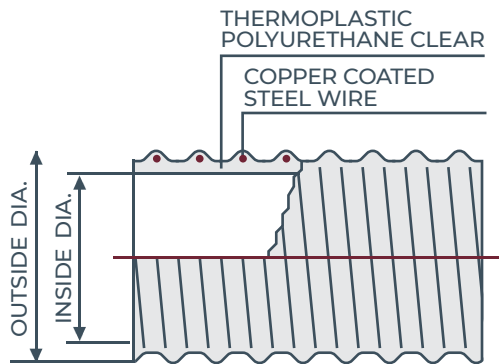

AVAILABLE SIZES

ID (inches)	OD (inches)	Minimum Bend Radius (72°F, inches)	Working Pressure (72°F, PSI)	Vacuum Rating (72°F, In Hg)	Weight (Lbs/Ft)	Standard Length (Ft)
3	3.150	3.5	30	29	0.50	25,50
4	4.250	4.5	20	28	0.72	25,50
5	5.300	5.5	18	27	0.80	25,50
6	6.340	6.5	15	24	1.16	25,50
7	7.420	7.5	13	20	1.24	25,50
8	8.460	8.5	10	12	1.36	25,50
10	10.560	11.5	7	10	2.04	25,50
12	12.600	13.5	6	8	2.25	25,50

Over flexing or repeated flexing of hose within 18" of fitting is a common cause of hose failure. Installing a 12"-14" section of our Banding Coil at the end of the hose should be considered. *Kanaflex will not be responsible for damage to hose due to over flexing.*



flexDUCT™ U 545 (545U)

Heavy-duty blower and ducting hose

A heavy-duty, abrasion-resistant ducting solution. The flexDUCT™ U 545 features a multi-directional, kink-resistant design with a copper-coated steel wire helix for static safety. Ideal for dust collection, vapor recovery, and woodworking, it performs reliably in temperatures from -60°F to 200°F.

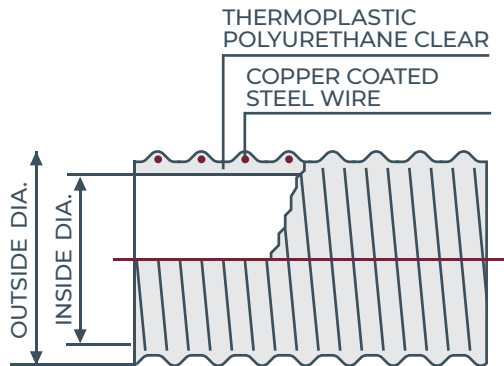

FEATURES

The multi-directional design allows the hose to flex in multiple directions without kinking or collapsing, making it ideal for dynamic environments where hoses must navigate around obstacles or move with equipment. For safety against static, the hose is also equipped with a copper coded steel wire helix.

APPLICATIONS

This product is specifically designed for applications requiring high abrasion resistance, including dust collection, vapor recovery, and woodworking.

CONSTRUCTION

Flexible clear polyurethane, copper coded steel wire helix, smooth bore, corrugated O.D., bi-directional design.

TEMP. RANGE

-60 °F to 200 °F

AVAILABLE SIZES

ID (inches)	OD (inches)	Minimum Bend Radius (72°F, inches)	Working Pressure (72°F, PSI)	Vacuum Rating (72°F, In Hg)	Weight (Lbs/Ft)	Standard Length (Ft)
3	3.150	5.0	30	29	0.60	25,50
4	4.250	7.0	21	28	0.83	25,50
5	5.300	8.0	19	27	0.93	25,50
6	6.340	9.0	16	24	1.28	25,50
7	7.420	10.0	14	20	1.42	25,50
8	8.460	11.0	12	12	2.00	25,50
10	10.560	12.0	10	10	2.30	25,50
12	12.600	15.0	8	8	3.05	25,50

Over flexing or repeated flexing of hose within 18" of fitting is a common cause of hose failure. Installing a 12"-14" section of our Banding Coil at the end of the hose should be considered. *Kanaflex will not be responsible for damage to hose due to over flexing.*



flexDUCT™ U 155 (155 U)

Heavy-duty blower and ducting hose

A versatile solution for demanding applications. Lightweight, flexible, and highly abrasion-resistant, with an ABS helix for increased flexibility with less volume. Ideal for mulch blowing, ducting, and ventilation across various industries. The bidirectional design ensures increased maneuverability for the operator.

FEATURES

Clear sidewall permits visual check of material flow. The smooth bore allows for precise flow because no irregularities in the wall can cause interruptions. The ABS helix provides increased flexibility, and the bidirectional design provides increased maneuverability. External helix provides for easy drag.

APPLICATIONS

This product is specifically designed for applications requiring high abrasion resistance, utilizing a hydro-stabilized, waterproof material that performs across a wide temperature range. Originally developed for mulch blower applications, the product is versatile enough for both indoor and outdoor use across various industries.

CONSTRUCTION

Flexible clear polyurethane, ABS helix, smooth bore, corrugated O.D., bi-directional design

TEMP. RANGE

-40 °F to 200 °F

NOTE

ABS is rigid when compared to typical hard PVC resin that is commonly used in light weight hose design. This benefit of incorporating ABS as the helix vs hard PVC helix is ABS requires less volume to support the same vacuum and pressure rating than a larger hard PVC Helix. This design results in increased flexibility, lighter weight providing increased maneuverability for the operator, making it a versatile hose for a variety of applications.

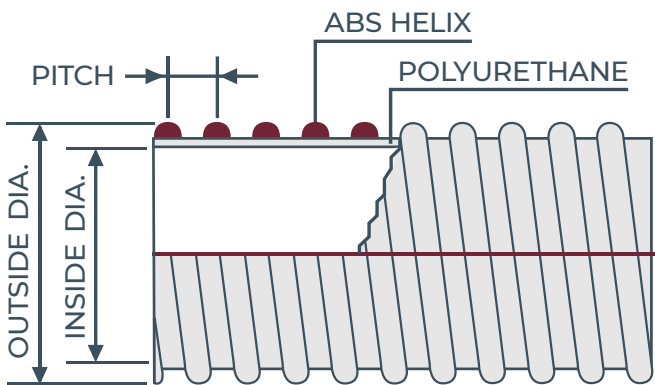

AVAILABLE SIZES

ID (inches)	OD (inches)	Pitch (inches)	Minimum Bend Radius (72°F, inches)	Working Pressure (72°F, PSI)	Vacuum Rating (72°F, In Hg)	Weight (Lbs/Ft)	Standard Length (Ft)
4	4.465	0.496	6.0	30	22.0	0.95	50
5	5.579	0.787	6.0	26	18.0	0.95	50

Over flexing or repeated flexing of hose within 18" of fitting is a common cause of hose failure. Installing a 12"-14" section of our Banding Coil at the end of the hose should be considered. *Kanaflex will not be responsible for damage to hose due to over flexing.*



flexDUCT™ U 140 ST (ST140U)

Polyurethane dry material handling hose

Built for high-performance dry material transfer, KanaVac U delivers abrasion resistance, sub-zero flexibility, and strong vacuum power—perfect for grain vacs and industrial vac systems.

FEATURES

Lightweight and flexible in sub-zero temperatures. Clear polyurethane lined PVC tube provides abrasion resistance, permits visual check of material flow, prevents material build up, and provides quiet operation. Corrugated PVC O.D. with raised PVC helix for increased flexibility and easy drag.

APPLICATIONS

Ag General Use, Air Seeder, Grain Vac, Industrial Plant Services General Use, Plastic Processing, Pneumatic Conveying, Vacuum Truck

CONSTRUCTION

Flexible polyurethane tube with rigid PVC helix, smooth bore, PVC corrugated O.D., no direction required, smooth bore, PVC corrugated O.D. with copper grounding wire.

TEMP. RANGE

-54°F to 140°F

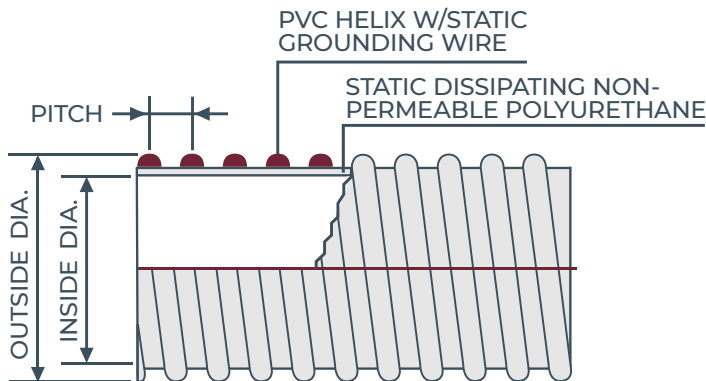

AVAILABLE SIZES

ID (inches)	OD (inches)	Pitch (inches)	Minimum Bend Radius (72°F, inches)	Working Pressure (72°F, PSI)	Vacuum Rating (72°F, In Hg)	Weight (Lbs/Ft)	Standard Length (Ft)
4	4.58	0.64	4	7	21	1.40	60
6	6.62	0.80	6	5	17	2.20	60

Over flexing or repeated flexing of hose within 18" of fitting is a common cause of hose failure. Installing a 12"-14" section of our Banding Coil at the end of the hose should be considered. *Kanaflex will not be responsible for damage to hose due to over flexing.*

flexFLO™





flexFLO™ U 190 (190U)

Medium-duty polyurethane material handling hose

Engineered for sub-zero flexibility, the clear polyurethane tube provides excellent abrasion resistance in both wet and dry conditions, allows visual monitoring of material flow, and ensures quiet operation. Ideal for air seeding and general agricultural applications, it offers extended service life and reliable performance.

FEATURES

Lightweight and flexible even in sub-zero temperatures, the clear polyurethane construction offers excellent abrasion resistance in both wet and dry conditions, allows visual inspection of material flow, prevents material buildup, and ensures quiet operation. The corrugated rigid polymer helix O.D. enhances flexibility and allows for easy dragging, while a specially developed rigid polymer provides additional strength, a wider temperature range, and reinforces the overall performance and durability of the hose.

APPLICATIONS

Ag general use, air seeder

CONSTRUCTION

Flexible clear polyurethane hose wall with a rigid polymer helix in red as standard, with various color options available; smooth bore and corrugated O.D.

TEMP. RANGE

- 40°F - 140°F

NOTE

Not a food-grade hose
190U comes in both clear/red and clear/black

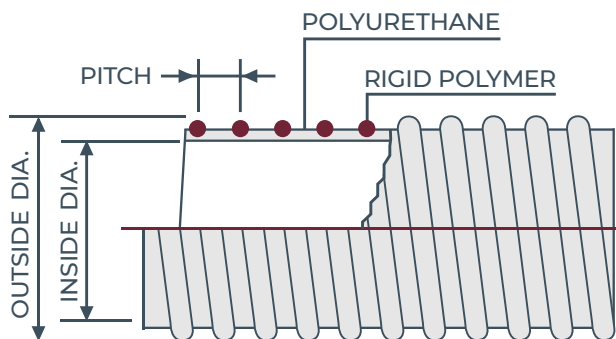

AVAILABLE SIZES

ID (inches)	OD (inches)	Pitch (inches)	Minimum Bend Radius (72°F, inches)	Working Pressure (72°F, PSI)	Vacuum Rating (72°F, in Hg)	Weight (Lbs/Ft)	Standard Length (Ft)
2-1/2	3.0	0.492	4.0	30	29.8	0.53	100
3	3.5	0.594	5.0	30	29.8	0.64	100

Over flexing or repeated flexing of hose within 18" of fitting is a common cause of hose failure. Installing a 12"-14" section of our Banding Coil at the end of the hose should be considered. *Kanaflex will not be responsible for damage to hose due to over flexing.*



flexFLO™ 114 (114 CL/114 GR)

Lightweight water suction and discharge hose

An ideal solution for various agricultural applications such as air seeder, fertilizer sprayer, foam markers, irrigation, and manure spreading. Lightweight, flexible, and featuring a clear sidewall for visual inspection, it ensures precise flow and optimal drainability.

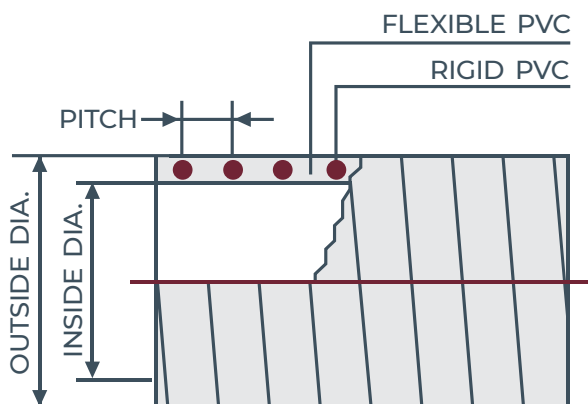

FEATURES

Lightweight and flexible water and suction hose. Clear sidewall permits visual check of material flow. The smooth bore allows for precise flow because no irregularities in the wall can cause interruptions. Smooth bore also promotes drainability.

APPLICATIONS

Economical water and suction hose with multiple agricultural applications including, air seeder, fertilizer sprayer, foam markers, irrigation, and manure spreading. Also useful in fish suction applications.

TEMP. RANGE

-13°F to 140°F

CONSTRUCTION

Flexible PVC, rigid PVC helix, smooth bore, smooth O.D.

NOTE

Not a food-grade hose

AVAILABLE SIZES

ID (inches)	OD (inches)	Pitch (inches)	Minimum Bend Radius (72°F, inches)	Working Pressure (72°F, PSI)	Vacuum Rating (72°F, In Hg)	Weight (Lbs/Ft)	Standard Length (Ft)
1-1/4	1.44	0.26	3.0	65.0	29.8	0.23	100
1-1/2	1.69	0.30	4.0	65.0	29.8	0.28	100
2	2.24	0.33	5.0	60.0	29.8	0.46	100
2-1/2	2.80	0.37	6.0	60.0	29.8	0.66	100
3	3.31	0.37	8.0	50.0	29.8	0.81	100
4	4.39	0.43	10.0	45.0	29.8	1.43	100

Over flexing or repeated flexing of hose within 18" of fitting is a common cause of hose failure. Installing a 12"-14" section of our Banding Coil at the end of the hose should be considered. *Kanaflex will not be responsible for damage to hose due to over flexing.*



flexFLO™ 116 Blue (116 Blue)

Cold weather water suction and discharge hose

An exceptional solution for demanding conditions. Designed to excel in cold weather, this hose ensures reliable water and suction performance with its durable construction.

FEATURES

A cold weather suction and discharge hose that will remain flexible in temperatures as cold as -40°F. Clear sidewall permits visual check of material flow. The smooth bore allows for precise flow because no irregularities in the wall can cause interruptions. Smooth bore also promotes drainability.

APPLICATIONS

Cold weather suction and discharge hose that can be used in agricultural applications on fertilizer sprayers and as an irrigation hose. It can also be used for water pumping in most construction applications.

TEMP. RANGE

-40°F to 140°F

CONSTRUCTION

Flexible PVC, rigid PVC helix, smooth bore, smooth O.D.

NOTE

Not a food-grade hose

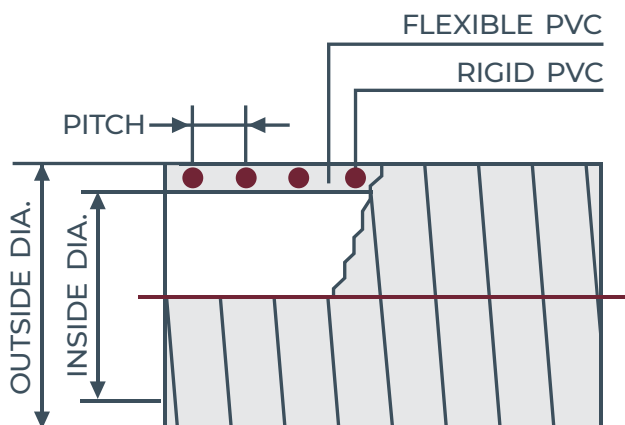

AVAILABLE SIZES

ID (inches)	OD (inches)	Pitch (inches)	Minimum Bend Radius (72°F, inches)	Working Pressure (72°F, PSI)	Vacuum Rating (72°F, In Hg)	Weight (Lbs/Ft)	Standard Length (Ft)
1	1.25	0.22	1.5	70	29.8	0.25	100
1-1/4	1.50	0.26	2.0	70	29.8	0.30	100
1-1/2	1.78	0.30	2.5	56	29.8	0.38	100
2	2.33	0.33	3.0	50	29.8	0.64	100
2-1/2	2.90	0.37	4.5	50	29.8	0.90	100
3	3.38	0.37	6.0	50	29.8	1.10	100
4	4.46	0.43	10.0	42	29.8	1.85	100
6	6.67	0.53	13.0	28	28.0	3.37	50, 100

Over flexing or repeated flexing of hose within 18" of fitting is a common cause of hose failure. Installing a 12"-14" section of our Banding Coil at the end of the hose should be considered. *Kanaflex will not be responsible for damage to hose due to over flexing.*



flexFLO™ lite 100 Blue (100 Blue)

Low temp general water suction and discharge hose

A versatile, lightweight solution for low temperature applications ranging from -40°F to 140°F. Constructed with cold weather PVC, a rigid PVC helix, smooth bore, and corrugated outer diameter, it offers increased flexibility and easy drag in sub-zero conditions. Ideal for general-duty water suction and discharge, with a clear sidewall for visual flow checks.

FEATURES

Lightweight with increased flexibility even at sub-zero temperatures. Clear sidewall permits visual check of material flow. External helix provides for easy drag.

APPLICATIONS

General-duty low temperature water suction and discharge hose with increased flexibility

TEMP. RANGE

-40°F to 140°F

CONSTRUCTION

Cold weather PVC, rigid PVC helix, smooth bore, corrugated O.D.

ACCESSORIES

Banding coil, Powerlock clamp

NOTE

Not a food-grade hose

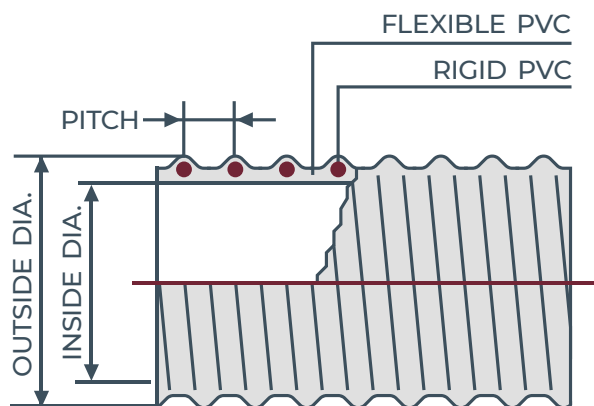

AVAILABLE SIZES

ID (inches)	OD (inches)	Pitch (inches)	Minimum Bend Radius (72°F, inches)	Working Pressure (72°F, PSI)	Vacuum Rating (72°F, in Hg)	Weight (Lbs/Ft)	Standard Length (Ft)
1	1.25	0.30	1.5	40	29.0	0.18	100
1-1/2	1.81	0.35	2.0	35	29.0	0.35	100
2	2.36	0.39	2.5	27	29.0	0.50	100
3	3.50	0.59	5.0	25	29.0	1.00	100
4	4.55	0.65	6.5	20	28.0	1.52	100
6	6.73	0.85	10.6	20	28.0	3.10	50, 100
8	9.04	0.91	16.0	20	28.0	5.38	25

Over flexing or repeated flexing of hose within 18" of fitting is a common cause of hose failure. Installing a 12"-14" section of our Banding Coil at the end of the hose should be considered. *Kanaflex will not be responsible for damage to hose due to over flexing.*



flexFLO™ lite 100 (100 CL)

General water suction and discharge hose

An adaptable solution for diverse applications. Constructed with flexible PVC, it offers easy drag with an external helix, clear sidewall for visual inspection, and smooth bore for precise flow and drainability. Ideal for water pumping on construction sites, as well as general use in agricultural and marine industries.

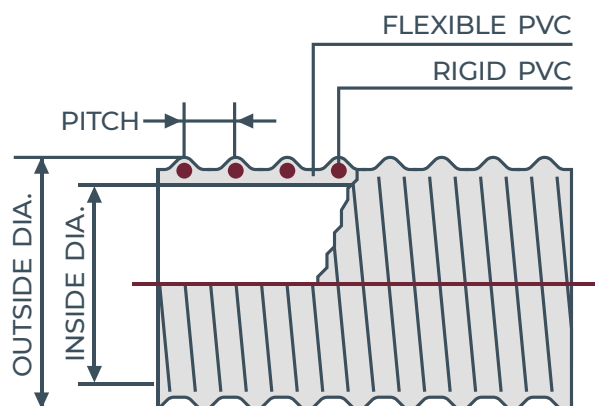

FEATURES

Lightweight and flexible hose constructed with flexible PVC. External helix provides for easy drag. Rated for both suction and discharge. Clear sidewall permits visual check of material flow. The smooth bore allows for precise flow because no irregularities in the wall can cause interruptions. Smooth bore also promotes drainability.

APPLICATIONS

The general water and suction hose that can be used for water pumping on construction sites and also serves as a general used hose in both the agricultural and marine industries.

TEMP. RANGE

-13°F to 140°F

CONSTRUCTION

Flexible PVC, rigid PVC helix, smooth bore, corrugated O.D.

NOTE

Not a food-grade hose

AVAILABLE SIZES

ID (inches)	OD (inches)	Pitch (inches)	Minimum Bend Radius (72°F, inches)	Working Pressure (72°F, PSI)	Vacuum Rating (72°F, in Hg)	Weight (Lbs/Ft)	Standard Length (Ft)
1	1.25	0.30	1.5	50	29.8	0.18	100
1-1/4	1.52	0.33	2.0	45	29.8	0.22	100
1-1/2	1.81	0.35	2.5	45	29.8	0.35	100
2	2.36	0.39	3.0	40	29.8	0.50	100
3	3.50	0.59	6.0	35	29.8	1.00	100
4	4.63	0.65	8.0	30	29.8	1.52	100

Over flexing or repeated flexing of hose within 18" of fitting is a common cause of hose failure. Installing a 12"-14" section of our Banding Coil at the end of the hose should be considered. *Kanaflex will not be responsible for damage to hose due to over flexing.*



flexFLO™ 110 (110 CL/110 GR)

Heavy-duty water suction and discharge hose

A versatile solution for agricultural, marine, and fish suction applications. Lightweight, flexible, and featuring a clear sidewall for visual inspection, it ensures precise flow in temperatures from -13°F to 140°F.

FEATURES

Lightweight and flexible water and suction hose. Clear sidewall permits visual check of material flow. The smooth bore allows for precise flow because no irregularities in the wall can cause interruptions. Smooth bore also promotes drainability.

APPLICATIONS

Heavy-duty water and suction hose with multiple agricultural applications including, air seeder, fertilizer sprayer, foam markers, irrigation, and manure spreading. Also useful in fish suction applications

TEMP. RANGE

-13°F to 140°F

CONSTRUCTION

Flexible PVC, rigid PVC helix, smooth bore, smooth O.D.

NOTE

Not a food-grade hose

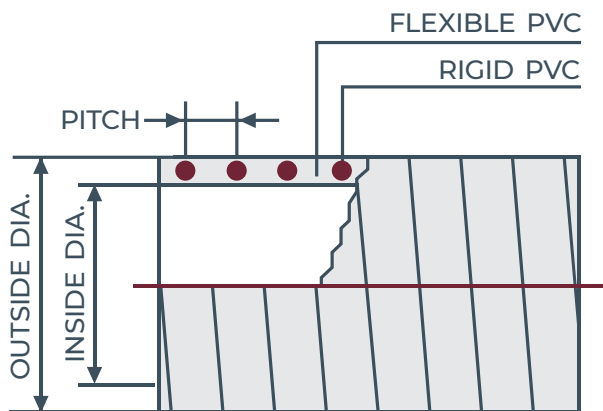

AVAILABLE SIZES

ID (inches)	OD (inches)	Pitch (inches)	Minimum Bend Radius (72°F, inches)	Working Pressure (72°F, PSI)	Vacuum Rating (72°F, In Hg)	Weight (Lbs/Ft)	Standard Length (Ft)
3/4	0.95	0.22	1.9	86	29.8	0.16	100
1	1.25	0.22	1.9	86	29.8	0.26	100
1-1/4	1.52	0.26	2.7	79	29.8	0.37	100
1-1/2	1.81	0.30	2.8	72	29.8	0.44	100
2	2.38	0.33	3.9	72	29.8	0.74	100
2-1/2	2.92	0.37	5.0	72	29.8	1.01	100
3	3.41	0.37	7.0	62	29.8	1.21	100
4	4.50	0.43	9.1	55	29.8	2.01	100
5	5.55	0.45	14.0	33	28.0	2.45	50, 100
6	6.67	0.53	15.0	33	28.0	3.37	50, 100
8	8.83	0.70	20.0	28	28.0	5.80	20, 25

Over flexing or repeated flexing of hose within 18" of fitting is a common cause of hose failure. Installing a 12"-14" section of our Banding Coil at the end of the hose should be considered. *Kanaflex will not be responsible for damage to hose due to over flexing.*



flexFLO™ 112 (112 CL/112 AG)

Economical heavy-duty water suction and discharge hose

An ideal solution for various agricultural applications such as air seeder, fertilizer sprayer, foam markers, irrigation, and manure spreading. Lightweight, flexible, and featuring a clear sidewall for visual inspection, it ensures precise flow and optimal drainability.

FEATURES

Lightweight and flexible water and suction hose. Clear sidewall permits visual check of material flow. The smooth bore allows for precise flow because no irregularities in the wall can cause interruptions. Smooth bore also promotes drainability.

APPLICATIONS

Economical water and suction hose with multiple agricultural applications including, air seeder, fertilizer sprayer, foam markers, irrigation, and manure spreading. Also useful in fish suction applications.

TEMP. RANGE

-13°F to 140°F

CONSTRUCTION

Flexible PVC, rigid PVC helix, smooth bore, smooth O.D.

NOTE

Not a food-grade hose

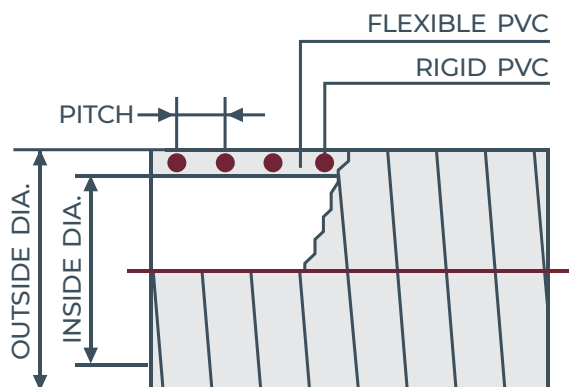

AVAILABLE SIZES

ID (inches)	OD (inches)	Pitch (inches)	Minimum Bend Radius (72°F, inches)	Working Pressure (72°F, PSI)	Vacuum Rating (72°F, In Hg)	Weight (Lbs/Ft)	Standard Length (Ft)
1-1/4	1.47	0.26	3.0	80	29.8	0.29	100
1-1/2	1.77	0.30	4.0	70	29.8	0.39	100
2	2.30	0.33	5.0	65	29.8	0.63	100
2-1/2	2.84	0.37	6.0	65	29.8	0.87	100
3	3.35	0.37	8.0	55	29.8	1.05	100
4	4.45	0.43	10.0	50	29.8	1.80	100

Over flexing or repeated flexing of hose within 18" of fitting is a common cause of hose failure. Installing a 12"-14" section of our Banding Coil at the end of the hose should be considered. *Kanaflex will not be responsible for damage to hose due to over flexing.*



flexFLO™ lite 100 CW (100 CWFLX)

Cold weather water suction and discharge hose

A versatile solution for demanding cold conditions. Constructed with cold weather PVC, it offers flexibility, easy drag with an external helix, and suitability for both suction and discharge. Ideal for water pumping on construction sites and widely applicable in agricultural and marine industries.

FEATURES

Lightweight and flexible hose constructed with cold weather PVC, making it perfect for the most demanding cold conditions. External helix provides for easy drag. Rated for both suction and discharge. Clear sidewall permits visual check of material flow.

APPLICATIONS

The general water and suction hose that can be used for water pumping on construction sites and also serves as a general used hose in both the agricultural and marine industries.

TEMP. RANGE

-40°F to 140°F

CONSTRUCTION

Cold weather PVC, rigid PVC helix, smooth bore, corrugated O.D.

ACCESSORIES

Banding coil, Powerlock clamp

NOTE

Not a food-grade hose

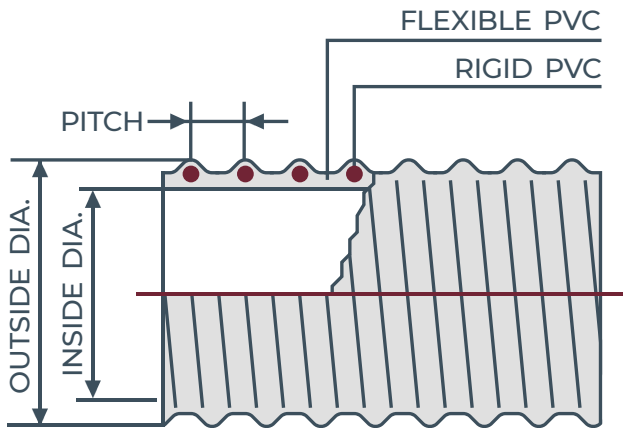

AVAILABLE SIZES

ID (inches)	OD (inches)	Pitch (inches)	Minimum Bend Radius (72°F, inches)	Working Pressure (72°F, PSI)	Vacuum Rating (72°F, In Hg)	Weight (Lbs/Ft)	Standard Length (Ft)
1	1.25	0.30	1.5	40	29.0	0.18	100
1-1/2	1.81	0.35	2.0	35	29.0	0.35	100
2	2.36	0.39	2.5	27	29.0	0.50	100
3	3.50	0.59	5.0	25	29.0	1.00	100
4	4.55	0.65	6.5	20	28.0	1.52	100*
5	5.73	0.85	10.5	20	28.0	2.50	50, 100*
6	6.73	0.85	10.6	20	28.0	3.10	50, 100*

Over flexing or repeated flexing of hose within 18" of fitting is a common cause of hose failure. Installing a 12"-14" section of our Banding Coil at the end of the hose should be considered. Kanaflex will not be responsible for damage to hose due to over flexing.

* 1,000 ft. order minimum for KanaLite CW



flexFLO™ lite U 100 (100 UCLRD)

Medium-duty polyurethane dry material handling hose

Engineered for sub-zero flexibility. With a clear polyurethane-lined PVC tube, it ensures abrasion resistance, visual material flow check, and quiet operation. Ideal for dry material pneumatic conveying, plastic pellet and powder transfer (non-static), and diverse agricultural applications.

FEATURES

Lightweight and flexible in sub-zero temperatures. Clear polyurethane lined PVC tube provides abrasion resistance, permits visual check of material flow, prevents material build up, and provides quiet operation. Corrugated PVC O.D. with raised PVC helix for increased flexibility and easy drag.

APPLICATIONS

Dry material pneumatic conveying systems and plastic pellet and powder transfer when static is not a concern. Agricultural applications, such as air seeders, abrasive material vacuum systems, and industrial vac equipment.

CONSTRUCTION

Flexible polyurethane lined PVC tube, rigid PVC helix, smooth bore, PVC corrugated O.D.

TEMP. RANGE

-13°F to 140°F

ACCESSORIES

Banding coil, Powerlock clamp

NOTE

Not a food-grade hose

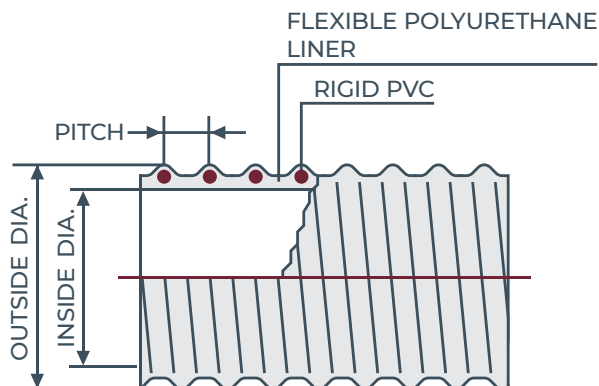

AVAILABLE SIZES

ID (inches)	OD (inches)	Pitch (inches)	Minimum Bend Radius (72°F, inches)	Working Pressure (72°F, PSI)	Vacuum Rating (72°F, In Hg)	Weight (Lbs/Ft)	Standard Length (Ft)
1	1.30	0.30	1.5	50	29.8	0.19	100*
1-1/4	1.58	0.33	2.0	45	29.8	0.24	100*
1-1/2	1.81	0.35	2.5	45	29.8	0.37	100*
2	2.36	0.39	3.0	40	29.8	0.50	100*
2-1/2	2.93	0.53	5.0	35	29.8	0.71	100
3	3.50	0.59	6.0	35	29.8	1.00	100
4	4.63	0.65	8.0	30	29.8	1.52	100**
5	5.73	0.87	11.0	30	28.0	2.50	50,100**
6	6.85	0.87	12.0	30	28.0	3.10	50,100**

Over flexing or repeated flexing of hose within 18" of fitting is a common cause of hose failure. Installing a 12"-14" section of our Banding Coil at the end of the hose should be considered. Kanaflex will not be responsible for damage to hose due to over flexing.

* 2,000 ft. order minimum

** 5,000 ft. order minimum

flexFlo™ Spa (SPA WHITE)



Flexible PVC spa hose

A versatile solution for spa applications. Flexible, lightweight, and featuring a smooth bore for precise flow and efficient drainability. Compatible with PVC solvent weld fittings only.

FEATURES

Flexible and lightweight. The smooth bore allows for precise flow because no irregularities in the wall can cause interruptions. Smooth bore also promotes drainability.

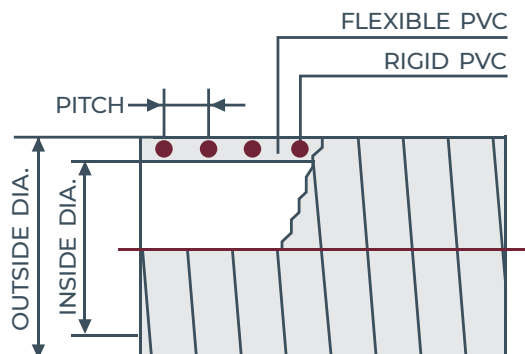

APPLICATIONS

Water lines, air lines, pump lines

CONSTRUCTION

Flexible PVC, rigid PVC helix, smooth bore, smooth O.D.

TEMP. RANGE

-13°F to 158°F

ACCESSORIES

For use with PVC solvent weld fittings only.

NOTE

Not a food-grade hose. For use with PVC solvent weld fittings only. Inside diameter is nominal.

Tolerance on outside diameter is + .020, - .005
See usage/storage suggestions and warranty information before use.

AVAILABLE SIZES

ID (inches)	OD (inches)	Pitch (inches)	Minimum Bend Radius (72°F, inches)	Working Pressure (72°F, PSI)	Vacuum Rating (72°F, In Hg)	Weight (Lbs/Ft)	Standard Length (Ft)
1/2	0.840	0.22	3.0	100	29.8	0.16	50,100
3/4	1.050	0.22	3.0	100	29.8	0.23	50,100
1	1.315	0.28	3.0	100	29.8	0.32	50,100
1-1/4	1.660	0.30	4.0	80	29.8	0.37	50,100
1-1/2	1.900	0.30	4.0	65	29.8	0.50	50,100
2	2.375	0.34	5.0	60	29.8	0.65	50,100

Like other materials, Spa Hoses can be damaged by rodents or insects, including termites. Our warranty does not cover damages caused by them. Spa Hose should not be used underground in areas infested by termites.



flexFLO™ U 113 (113UVCLBK)

All weather suction and discharge hose

An agile solution for diverse agricultural needs. Lightweight and flexible, its blended polyurethane construction enhances abrasion and UV resistance. Ideal for air seeder, fertilizer sprayer, foam markers, irrigation, manure spreading, and fish suction applications.

FEATURES

Lightweight and flexible water and suction hose. Improved abrasion and UltraViolet resistance because of the blended polyurethane construction. Clear sidewall permits visual check of material flow. The smooth bore allows for precise flow because no irregularities in the wall can cause interruptions. Smooth bore also promotes drainability.

APPLICATIONS

All weather water and suction hose with multiple agricultural applications including, air seeder, fertilizer sprayer, foam markers, irrigation, and manure spreading. Also useful in fish suction applications.

TEMP. RANGE

-13°F to 140°F

CONSTRUCTION

Flexible PVC blended with polyurethane, rigid PVC helix, smooth bore, smooth O.D.

NOTE

Not a food-grade hose

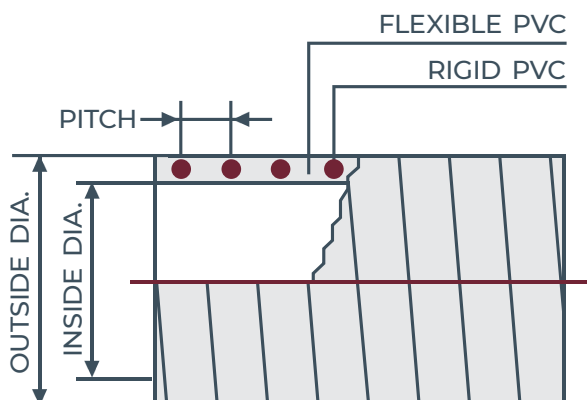

AVAILABLE SIZES

ID (inches)	OD (inches)	Pitch (inches)	Minimum Bend Radius (72°F, inches)	Working Pressure (72°F, PSI)	Vacuum Rating (72°F, In Hg)	Weight (Lbs/Ft)	Standard Length (Ft)
1	1.25	0.22	1.9	86	29.8	0.25	100
1-1/4	1.47	0.26	3.0	80	29.8	0.25	100
1-1/2	1.77	0.30	4.0	70	29.8	0.39	100
1-3/4	2.00	0.30	4.5	65	29.8	0.48	100
2	2.30	0.33	5.0	65	29.8	0.63	100
2-1/2	2.84	0.37	6.0	65	29.8	0.87	100
3	3.35	0.37	8.0	55	29.8	1.05	100

Over flexing or repeated flexing of hose within 18" of fitting is a common cause of hose failure. Installing a 12"-14" section of our Banding Coil at the end of the hose should be considered. *Kanaflex will not be responsible for damage to hose due to over flexing.*



flexFLO™ 100 HD (100 CKBK HD)

Heavy-duty, kink-resistant, suction and discharge hose.

The ultimate industrial solution for challenging environments. This heavy-duty suction and discharge hose combines flexibility with unparalleled durability, making it ideal for demanding construction and dewatering applications. Engineered with cold weather PVC and a robust, enlarged helix, the flexFlo 100 HD ensures smooth operation in the coldest conditions.

FEATURES

Lightweight and flexible hose constructed with cold weather PVC, making it perfect for the most demanding cold conditions. External helix provides for easy drag. Helix is 30% larger than KanaLite CW. Rated for both suction and discharge. Clear sidewall permits visual check of material flow.

APPLICATIONS

Designed for construction application, dewatering

TEMP. RANGE

-40°F to 140°F

CONSTRUCTION

Cold weather PVC, rigid and enlarged PVC helix, smooth bore, corrugated O.D.

ACCESSORIES

Banding coil, Powerlock clamp

NOTE

Not a food-grade hose

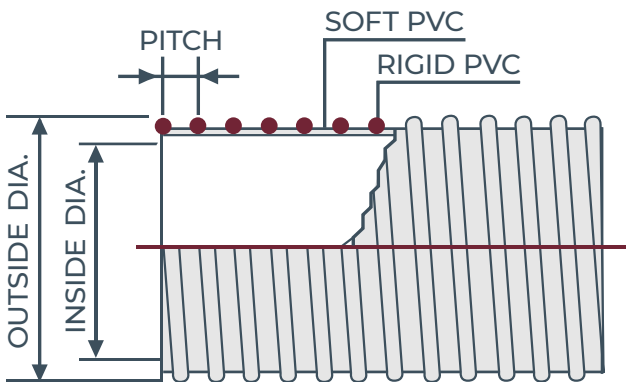

AVAILABLE SIZES

ID (inches)	OD (inches)	Pitch (inches)	Minimum Bend Radius (72°F, inches)	Working Pressure (72°F, PSI)	Vacuum Rating (72°F, In Hg)	Weight (Lbs/Ft)	Standard Length (Ft)
6	6.67	0.78	9.0	20.0	28.0	3.58	100

Over flexing or repeated flexing of hose within 18" of fitting is a common cause of hose failure. Installing a 12"-14" section of our Banding Coil at the end of the hose should be considered. *Kanaflex will not be responsible for damage to hose due to over flexing.*

flexFOOD™





flexFOOD™ 215 CB (KRCB)

Clear, flexible PVC food and beverage hose

A food-grade suction and discharge hose designed for versatile use across construction, industrial, and agricultural applications, including food, beverage dispensing, and air and water lines.

FEATURES

This hose is made from FDA, 3A, and NSF-approved clear PVC for safe food contact and is NSF-51 compliant for food equipment use. Reinforced with high-strength yarn for durability, it offers flexibility, easy handling, and a smooth interior for efficient flow and cleaning. The lightweight design resists kinking, crushing, and collapse, while the transparent wall allows quick visual inspection.

APPLICATIONS

Food and beverage transfer

CONSTRUCTION

Produced entirely of compounds in compliance with FDA, 3-A nontoxic and NSF specifications, flexible PVC, synthetic braiding, smooth bore, smooth O.D.

TEMP. RANGE

-13°F to 140°F

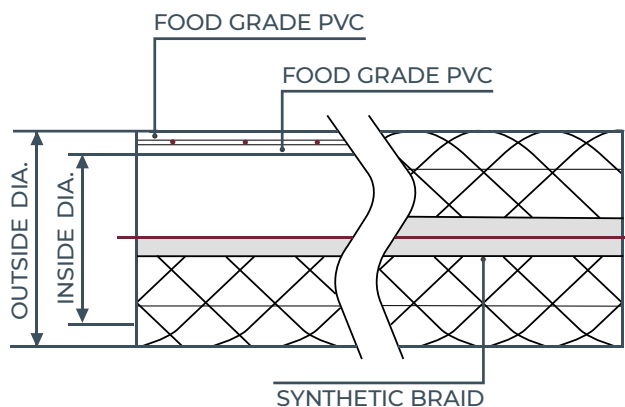

AVAILABLE SIZES

ID (inches)	OD (inches)	Working Pressure (72°F, PSI)	Weight (Lbs/Ft)	Standard Length (Ft)
3/16	0.42	250	0.05	300
1/4	0.46	250	0.06	300
5/16	0.53	250	0.08	300
3/8	0.63	230	0.10	300
1/2	0.75	220	0.13	300
5/8	0.92	210	0.18	200
3/4	1.03	160	0.21	200
1	1.32	125	0.31	200

Over flexing or repeated flexing of hose within 18" of fitting is a common cause of hose failure. Installing a 12"-14" section of our Banding Coil at the end of the hose should be considered. *Kanaflex will not be responsible for damage to hose due to over flexing.*



flexFOOD™ lite 200 (200 SFG)

Food grade suction and discharge hose

Meticulously crafted to meet FDA and 3-A nontoxic standards. With a clear sidewall for visual inspection and a smooth bore ensuring precise flow and optimal drainability.

FEATURES

The food grade hose is constructed in compliance with FDA and 3-A nontoxic specifications. Clear sidewall permits visual check of material flow. The smooth bore allows for precise flow because no irregularities in the wall can cause interruptions. Smooth bore also promotes drainability.

APPLICATIONS

Food grade suction hose for use in canning, dairy and bottling.

CONSTRUCTION

Produced entirely of compounds in compliance with FDA and 3-A non toxic specifications, flexible PVC, rigid PVC helix, smooth bore, corrugated O.D.

TEMP. RANGE

-13°F to 140°F

NOTE

Made with NSF51 approved materials

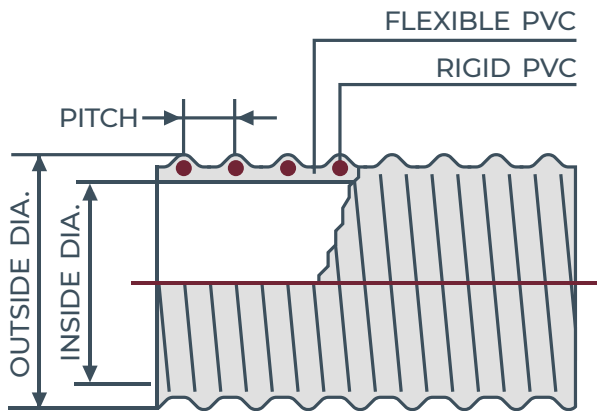

AVAILABLE SIZES

ID (inches)	OD (inches)	Pitch (inches)	Minimum Bend Radius (72°F, inches)	Working Pressure (72°F, PSI)	Vacuum Rating (72°F, In Hg)	Weight (Lbs/Ft)	Standard Length (Ft)
1	1.25	0.30	1.5	50	29.8	0.18	100
1-1/4	1.52	0.33	2.0	45	29.8	0.22	100
1-1/2	1.81	0.35	2.5	45	29.8	0.35	100
2	2.36	0.39	4.0	40	29.8	0.50	100
2-1/2	2.87	0.56	4.5	35	29.8	0.68	100
3	3.50	0.59	6.0	35	29.8	1.00	100
4	4.63	0.65	8.0	30	29.8	1.52	100

Over flexing or repeated flexing of hose within 18" of fitting is a common cause of hose failure. Installing a 12"-14" section of our Banding Coil at the end of the hose should be considered. *Kanaflex will not be responsible for damage to hose due to over flexing.*



flexFOOD™ lite 200 ST (ST 200SFG)

Medium-duty food grade suction and discharge hose

Crafted to FDA and 3-A nontoxic standards. Ideal for pneumatic conveying of lightweight solids, featuring a clear sidewall, static grounding wire, smooth bore for precise flow, and drainability. Please note, it is not intended for conveying edible food products.

FEATURES

The food grade hose is constructed in compliance with FDA and 3-A nontoxic specifications. Clear sidewall permits visual check of material flow. Static grounding wire dissipates static charge when connected to a grounded system. The smooth bore allows for precise flow because no irregularities in the wall can cause interruptions. Smooth bore also promotes drainability.

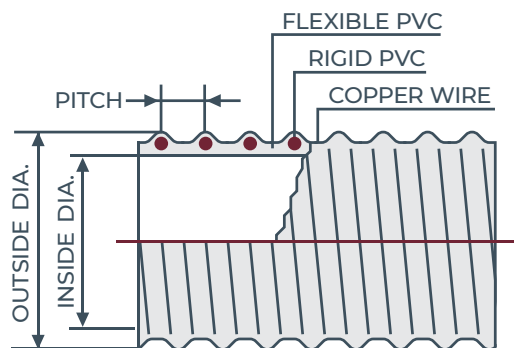

APPLICATIONS

Pneumatic conveying of lightweight solids such as powders and plastic pellets. Copper static wire is located within the hose tube. Not to be used for conveying edible food products.

CONSTRUCTION

Produced entirely of compounds in compliance with FDA and 3-A nontoxic specifications, flexible PVC, rigid PVC helix, multi-strand copper static grounding wire, smooth bore, corrugated O.D.

TEMP. RANGE

-13°F to 140°F

NOTE

Made with NSF51 approved materials. If used for abrasive materials, monitor the hose for excessive wear. Excessive wear may expose the material to the copper static wire.

AVAILABLE SIZES

ID (inches)	OD (inches)	Pitch (inches)	Minimum Bend Radius (72°F, inches)	Working Pressure (72°F, PSI)	Vacuum Rating (72°F, In Hg)	Weight (Lbs/Ft)	Standard Length (Ft)
1-1/2	1.81	0.35	2.5	45	29.8	0.44	50,100
2	2.36	0.39	4.0	40	29.8	0.58	50,100
2-1/2	2.87	0.56	4.5	35	29.8	0.75	50,100
3	3.50	0.59	6.0	35	29.8	1.07	50,100
4	4.63	0.65	8.0	30	29.8	1.52	50,100

Over flexing or repeated flexing of hose within 18" of fitting is a common cause of hose failure. Installing a 12"-14" section of our Banding Coil at the end of the hose should be considered. *Kanaflex will not be responsible for damage to hose due to over flexing.*



flexFOOD™ Milk 212 (212 MK)

Heavy-duty food grade suction and discharge hose

Crafted to FDA and 3-A nontoxic standards. Ideal for milk hauling (tank truck) and pick-up, offering flexibility, visual clarity, precise flow, and optimal drainability.

FEATURES

The food grade hose is constructed in compliance with FDA and 3-A nontoxic specifications. Clear sidewall permits visual check of material flow. The smooth bore allows for precise flow because no irregularities in the wall can cause interruptions. Smooth bore also promotes drainability.

APPLICATIONS

A more flexible version of our KanaFlo FG hose. The KanaFlo MK hose is designed specifically for milk hauling (tank truck) and pick-up.

CONSTRUCTION

Produced entirely of compounds in compliance with FDA and 3-A nontoxic specifications, flexible PVC, rigid PVC helix, smooth bore, smooth O.D.

TEMP. RANGE

-13°F to 140°F

NOTE

Made with NSF51 approved materials

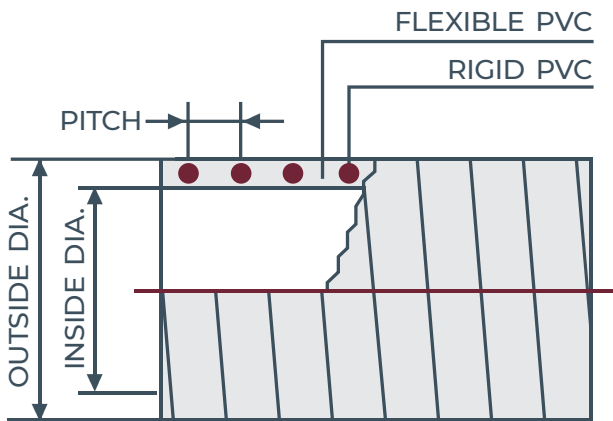

AVAILABLE SIZES

ID (inches)	OD (inches)	Pitch (inches)	Minimum Bend Radius (72°F, inches)	Working Pressure (72°F, PSI)	Vacuum Rating (72°F, In Hg)	Weight (Lbs/Ft)	Standard Length (Ft)
1-1/2	1.82	0.30	2.0	66	29.8	0.44	100
2	2.39	0.33	2.5	66	29.8	0.74	100
2-1/2	2.93	0.37	4.7	66	29.8	1.01	100
3	3.43	0.37	6.1	62	29.8	1.21	100

Over flexing or repeated flexing of hose within 18" of fitting is a common cause of hose failure. Installing a 12"-14" section of our Banding Coil at the end of the hose should be considered. *Kanaflex will not be responsible for damage to hose due to over flexing.*



flexFOOD™ 210 (210 HFG)

Heavy-duty food grade suction and discharge hose

Meticulously crafted to meet FDA and 3-A nontoxic standards. With a clear sidewall for visual inspection and a smooth bore ensuring precise flow and optimal drainability.

FEATURES

The food grade hose is constructed in compliance with FDA and 3-A nontoxic specifications. Clear sidewall permits visual check of material flow. The smooth bore allows for precise flow because no irregularities in the wall can cause interruptions. Smooth bore also promotes drainability.

APPLICATIONS

A food grade suction and discharge hose can be used in food and wine processing applications as well as milk trucks.

CONSTRUCTION

Produced entirely of compounds in compliance with FDA and 3-A nontoxic specifications, flexible PVC, rigid PVC helix, smooth bore, smooth O.D.

TEMP. RANGE

-13°F to 140°F

NOTE

Made with NSF51 approved materials

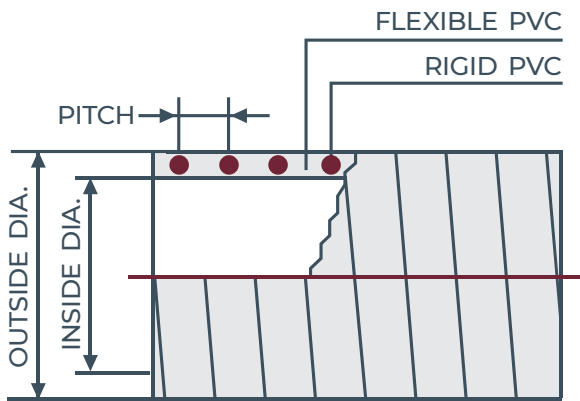

AVAILABLE SIZES

ID (inches)	OD (inches)	Pitch (inches)	Minimum Bend Radius (72°F, inches)	Working Pressure (72°F, PSI)	Vacuum Rating (72°F, In Hg)	Weight (Lbs/Ft)	Standard Length (Ft)
3/4	0.96	0.22	1.9	86	29.8	0.16	100
1	1.25	0.22	1.9	86	29.8	0.26	100
1-1/4	1.54	0.26	2.7	79	29.8	0.37	100
1-1/2	1.82	0.30	2.8	72	29.8	0.44	100
2	2.39	0.33	3.9	72	29.8	0.74	100
2-1/2	2.93	0.37	5.0	72	29.8	1.01	100
3	3.43	0.37	7.0	62	29.8	1.21	100
4	4.53	0.43	9.1	55	29.8	2.01	100

Over flexing or repeated flexing of hose within 18" of fitting is a common cause of hose failure. Installing a 12"-14" section of our Banding Coil at the end of the hose should be considered. *Kanaflex will not be responsible for damage to hose due to over flexing.*

flex**FORCE**™

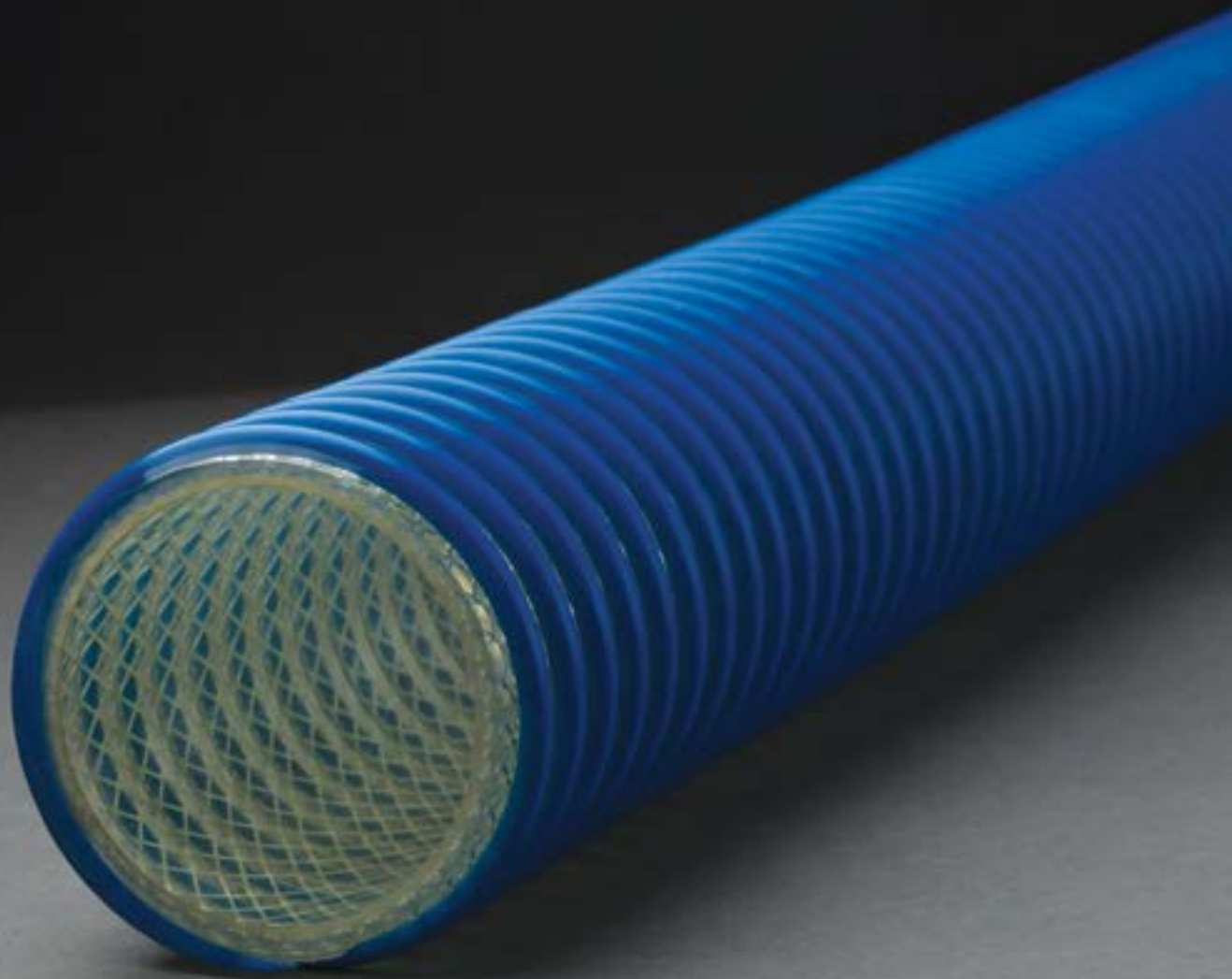



flexFORCE™ Blue (KANALINE BLUE)

Reinforced cold weather suction and discharge hose

A versatile solution for combined vacuum, higher working pressures, and increased flexibility. Lightweight and flexible with an external helix for easy drag, it's ideal for colder environments and liquid fertilizer applications. Constructed with flexible cold weather PVC, a rigid PVC helix, synthetic braiding, smooth bore, and corrugated outer diameter, it ensures reliable performance and visual material flow checks.

FEATURES

Lightweight and flexible hose constructed with cold weather PVC, making it perfect for the most demanding cold conditions. The synthetic braiding gives the hose increased flexibility and durability. External helix provides for easy drag. Rated for both suction and discharge. Clear sidewall permits visual check of material flow.

APPLICATIONS

The reinforced cold weather suction and discharge hose can be used in the spreading of liquid fertilizer in agricultural applications. It can also be used in the fishing industry for both fish suction and ice slinging.

TEMP. RANGE

-40°F to 140°F

CONSTRUCTION

Flexible cold weather PVC, rigid PVC helix, synthetic braiding, smooth bore, corrugated O.D.

ACCESSORIES

Banding coil, Powerlock clamp

NOTE

Not a food-grade hose. Banding coil must be used for all sizes.

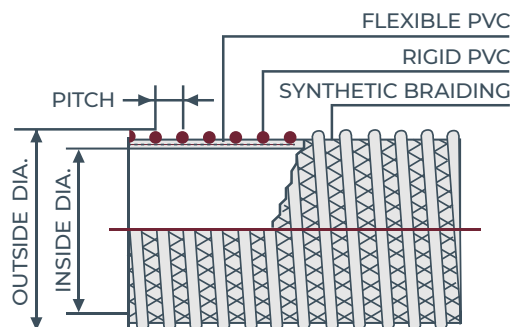

AVAILABLE SIZES

ID (inches)	OD (inches)	Pitch (inches)	Minimum Bend Radius (72°F, inches)	Working Pressure (72°F, PSI)	Vacuum Rating (72°F, In Hg)	Weight (Lbs/Ft)	Standard Length (Ft)
1-1/2	2.10	0.37	2.0	75	28.0	0.47	60,100
2	2.60	0.43	3.0	70	28.0	0.70	60,100
3	3.70	0.59	5.0	70	28.0	1.13	60,100
4	4.80	0.63	7.0	60	28.0	1.74	60,100
6	7.30	0.98	9.0	50	28.0	3.88	60,100
8	9.50	1.07	15.0	40	28.0	5.54	15,20,25,40
10	11.63	1.22	24.5	30	28.0	8.68	20,25,40*
12	13.80	1.34	43.0	20	25.0	10.30	20*

Over flexing or repeated flexing of hose within 18" of fitting is a common cause of hose failure. Installing a 12"-14" section of our Banding Coil at the end of the hose should be considered. Kanaflex will not be responsible for damage to hose due to over flexing.

*Buyer responsible for shipping costs



flexFORCE™ CW (KLCWB)

Reinforced cold weather suction and discharge hose

A versatile solution designed for extreme cold conditions. Lightweight with cold weather PVC and synthetic braiding for flexibility and durability. Ideal for liquid fertilizer spreading in agriculture and fish suction and ice slinging in the fishing industry.

FEATURES

Lightweight and flexible hose constructed with cold weather PVC, making it perfect for the most demanding cold conditions. The synthetic braiding gives the hose increased flexibility and durability. External helix provides for easy drag. Rated for both suction and discharge. Clear sidewall permits visual check of material flow.

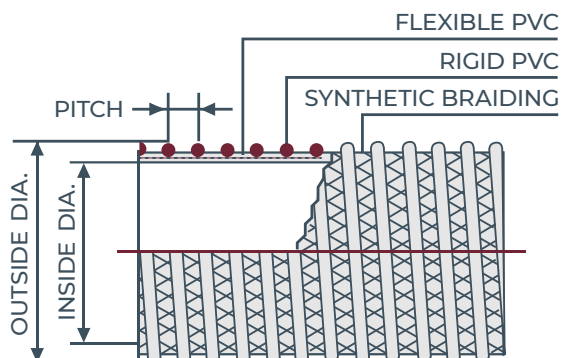

APPLICATIONS

The reinforced cold weather suction and discharge hose can be used in the spreading of liquid fertilizer in agricultural applications. It can also be used in the fishing industry for both fish suction and ice slinging.

TEMP. RANGE

-40°F to 140°F

CONSTRUCTION

Flexible cold weather PVC, rigid PVC helix, synthetic braiding, smooth bore, corrugated O.D.

ACCESSORIES

Banding coil, Powerlock clamp

NOTE

Not a food-grade hose. Banding coil must be used for all sizes.

AVAILABLE SIZES

ID (inches)	OD (inches)	Pitch (inches)	Minimum Bend Radius (72°F, inches)	Working Pressure (72°F, PSI)	Vacuum Rating (72°F, In Hg)	Weight (Lbs/Ft)	Standard Length (Ft)
1-1/2	2.10	0.37	2.0	75	28.0	0.47	60,100
2	2.60	0.43	3.0	70	28.0	0.70	60,100
3	3.70	0.59	5.0	70	28.0	1.13	60,100
4	4.80	0.63	7.0	60	28.0	1.74	60,100
6	7.30	0.98	9.0	50	28.0	3.88	60,100
8	9.50	1.07	15.0	40	28.0	5.54	15,20,25,40
10	11.63	1.22	24.5	30	28.0	8.68	Not stock item

Over flexing or repeated flexing of hose within 18" of fitting is a common cause of hose failure. Installing a 12"-14" section of our Banding Coil at the end of the hose should be considered. *Kanaflex will not be responsible for damage to hose due to over flexing.*



flexFORCE™ Food Grade (KLFW)

Heavy-duty reinforced food grade suction and discharge hose

A versatile solution for bottling, wine making, canning, dairy, brewing, and liquid foods. Lightweight, flexible, and constructed with FDA and 3-A compliant materials.

FEATURES

Lightweight and flexible. Clear food-grade flexible PVC with synthetic braiding provides increased abrasion resistance, permits visual check of material flow, and prevents material build up. External helix provides for easy drag. Rated for both suction and discharge.

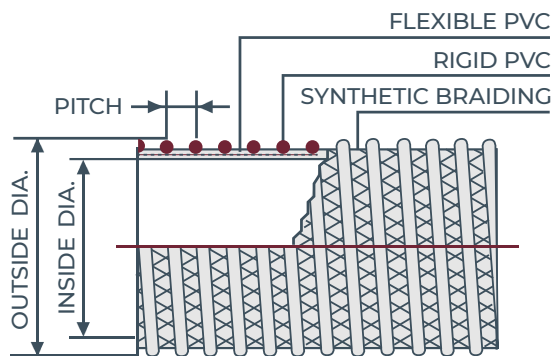

APPLICATIONS

Heavy-duty reinforced food grade suction and discharge hose for bottling, wine making, canning, dairy, brewing and liquid foods

CONSTRUCTION

Produced entirely of compounds in compliance with FDA and 3-A nontoxic specifications, flexible PVC, rigid PVC helix, synthetic braiding, smooth bore, corrugated O.D.

TEMP. RANGE

-13°F to 140°F

ACCESSORIES

Banding coil, Powerlock clamp

NOTE

Made with NSF51 approved materials. Banding coil must be used for all sizes. 5" and 6" sizes are not a stock items. Consult factory for availability.

AVAILABLE SIZES

ID (inches)	OD (inches)	Pitch (inches)	Minimum Bend Radius (72°F, inches)	Working Pressure (72°F, PSI)	Vacuum Rating (72°F, In Hg)	Weight (Lbs/Ft)	Standard Length (Ft)
1-1/2	2.1	0.39	2.5	110	28.0	0.56	60,100
2	2.6	0.41	4.0	100	28.0	0.75	60,100
3	3.7	0.59	6.3	100	28.0	1.20	60,100
4	4.8	0.65	7.1	75	28.0	1.74	60,100
5	6.1	0.87	9.2	70	28.0	2.90	Not stock item
6	7.3	0.93	10.2	70	28.0	3.88	Not stock item

Over flexing or repeated flexing of hose within 18" of fitting is a common cause of hose failure. Installing a 12"-14" section of our Banding Coil at the end of the hose should be considered. *Kanaflex will not be responsible for damage to hose due to over flexing.*



flexFORCE™ SR (KLSR)

Water suction and discharge hose for heavy-duty applications requiring combined vacuum and higher working pressures

A lightweight and flexible solution with easy drag. Ideal for fish suction, rental/construction pumping, and agricultural irrigation, featuring a clear sidewall for visual inspection and a smooth bore for precise flow and enhanced drainability.

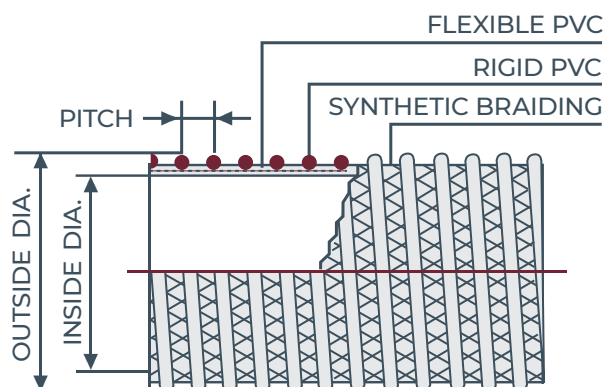

FEATURES

Lightweight and flexible with an external helix that provides for easy drag. Clear sidewall permits visual check of material flow. The smooth bore allows for precise flow because no irregularities in the wall can cause interruptions. Smooth bore also promotes drainability.

APPLICATIONS

Heavy duty suction and discharge hose for use in fish suction, rental/construction pumping, and agricultural irrigation.

TEMP. RANGE

-13°F to 140°F

CONSTRUCTION

Flexible PVC, rigid PVC helix, synthetic braiding, smooth bore, corrugated O.D.

ACCESSORIES

Banding coil, Powerlock clamp

NOTE

Not a food-grade hose. Banding coil must be used for 1-1/2", 2", 3", 4", 5" and 6" sizes.

AVAILABLE SIZES

ID (inches)	OD (inches)	Pitch (inches)	Minimum Bend Radius (72°F, inches)	Working Pressure (72°F, PSI)	Vacuum Rating (72°F, In Hg)	Weight (Lbs/Ft)	Standard Length (Ft)
1-1/2	2.1	0.37	2.5	110	28.0	0.47	60,100
2	2.6	0.43	4.0	100	28.0	0.70	60,100
3	3.7	0.59	6.3	100	28.0	1.13	60,100
4	4.8	0.65	7.1	75	28.0	1.74	60,100
5	6.1	0.87	9.2	70	28.0	2.90	60,100
6	7.2	0.93	10.2	70	28.0	3.88	60,100
8	9.5	1.07	15.7	60	28.0	5.54	15,20,25,40*
10	11.63	1.22	24.8	40	28.0	8.68	15,20,25,40*
12	13.8	1.34	45.0	28	25.0	10.30	20,40*

Over flexing or repeated flexing of hose within 18" of fitting is a common cause of hose failure. Installing a 12"-14" section of our Banding Coil at the end of the hose should be considered. Kanaflex will not be responsible for damage to hose due to over flexing.

* Buyer responsible for shipping costs



flexFORCE™ U Food Grade (STKLUFG)

Heavy-duty reinforced polyurethane food-grade suction and discharge hose

An ideal for sub-zero conditions. Featuring a clear food-grade polyurethane tube, static grounding, and dissipative materials, it ensures safe and efficient transfer of abrasive/food grade materials. Perfect for bulk unloading and fish suction applications.

FEATURES

Lightweight and flexible in sub-zero temperatures. Clear food-grade polyurethane tube provides increased abrasion resistance, permits visual check of material flow, prevents material build up and provides quiet operation. Static grounding wire and dissipative material in construction dissipates static charge when connected to a grounded system. External helix provides for easy drag.

APPLICATIONS

Transfer of abrasive/food grade materials - bulk unloading of railcars and trucks. Fish suction.

CONSTRUCTION

Flexible static dissipative polyurethane liner and PVC, rigid PVC helix, synthetic braiding, no direction required, smooth bore, PVC corrugated O.D. with copper grounding wire. Produced entirely of compounds in compliance with FDA and 3-A non-toxic specifications.

TEMP. RANGE

-33°F to 140°F

ACCESSORIES

Banding coil or Powerlock Clamp must be used for all sizes. Static wire must be properly imbedded during fitting installation and tested to assure proper static grounding of hose to a grounded system.

NOTE

Made with NSF51 approved materials

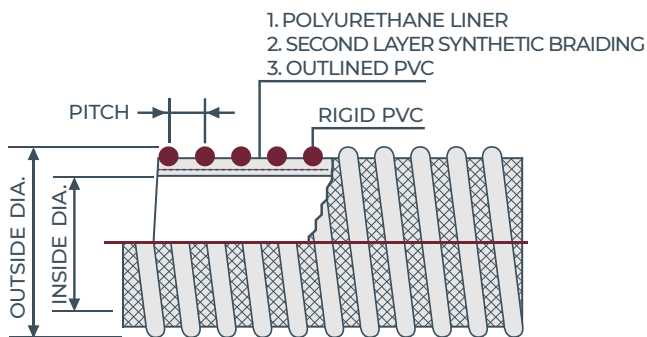

AVAILABLE SIZES

ID (inches)	OD (inches)	Pitch (inches)	Minimum Bend Radius (72°F, inches)	Working Pressure (72°F, PSI)	Vacuum Rating (72°F, In Hg)	Weight (Lbs/Ft)	Standard Length (Ft)
3	3.7	0.59	6.3	100	28.0	1.26	60
4	4.8	0.69	7.5	75	28.0	1.94	60, 100
5	6.1	1.00	9.5	70	28.0	3.20	60, 100
6	7.2	1.00	11.0	70	28.0	4.34	60, 100

Over flexing or repeated flexing of hose within 18" of fitting is a common cause of hose failure. Installing a 12"-14" section of our Banding Coil at the end of the hose should be considered. *Kanaflex will not be responsible for damage to hose due to over flexing.*

flex**FUEL**™





flexFUEL™ lite 120 ST (ST 120 LT)

All purpose tank truck drop hose

A lightweight and flexible solution. Featuring a nitrile rubber static dissipating tube and grounding wire for maximum static resistance. Perfect for gasoline gravity drops of naphtha, kerosene, oil, diesel, and ethanol blends with an external helix for easy handling.

FEATURES

Lightweight and flexible. Nitrile rubber static dissipating tube and static grounding wire provide maximum static resistance when connected to a grounded system. Construction makes it up to 50% lighter than the average rubber drop hose. External helix provides for easy drag. Rated for up to 40% aromatic content.

APPLICATIONS

Gasoline tank truck gravity drop hose for fluids such as naphtha, kerosene, light and heavy oil, diesel and some ethanol.

CONSTRUCTION

Nitrile rubber static dissipating tube, rigid PVC helix, synthetic braiding, smooth bore, static grounding wire, corrugated O.D.

TEMP. RANGE

-30°F to 140°F

ACCESSORIES

Banding coil or banding sleeve

NOTE

Banding sleeves or banding coils must be used for all sizes. Static wire must be properly imbedded during fitting installation and tested to assure proper static grounding of hose to a grounded system.

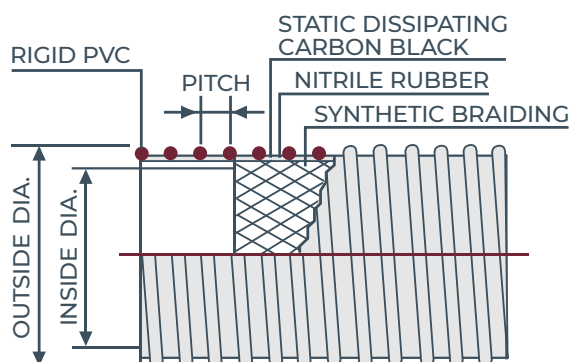

AVAILABLE SIZES

ID (inches)	OD (inches)	Pitch (inches)	Minimum Bend Radius (72°F, inches)	Working Pressure (72°F, PSI)	Vacuum Rating (72°F, In Hg)	Weight (Lbs/Ft)	Standard Length (Ft)
2	2.68	0.39	5.0	65	29.8	1.13	60,100
3	3.8	0.59	6.0	65	29.8	1.37	60,100
4	4.9	0.65	8.0	65	29.8	2.16	60,100

Over flexing or repeated flexing of hose within 18" of fitting is a common cause of hose failure. Installing a 12"-14" section of our Banding Coil at the end of the hose should be considered. *Kanaflex will not be responsible for damage to hose due to over flexing.*



flexFUEL™ U 120 ST (ST 120 UAPDH)

All purpose polyurethane tank truck drop hose

An exceptional solution for various fuels. Lightweight and flexible, with a static dissipating polyurethane inner and outer tube, it resists gasoline, biodiesel, ethanol, kerosene, and diesel. Ideal for gravity drop applications with a clear tube for visual flow confirmation.

FEATURES

Lightweight and flexible even in sub-zero temperatures. Static dissipating polyurethane inner and outer tube provides maximum resistance to gasoline, biodiesel (up to B100 compliant with ASTM D6751), ethanol (E85 to E100), kerosene, diesel and ASTM fuel oils. Clear tube allows visual confirmation of flow.

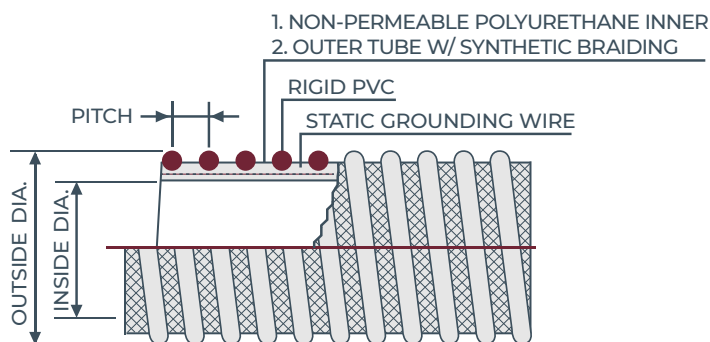

APPLICATIONS

All purpose tank truck gravity drop hose for items such as gasoline, ethanol, biodiesel, kerosene and diesel.

CONSTRUCTION

Non-permeable polyurethane inner and outer tube with synthetic braiding, smooth bore, corrugated O.D., PVC helix for easy drag, clear static dissipating tube and multi-strand copper static wire providing maximum protection against static discharge.

TEMP. RANGE

-52°F to 140°F

ACCESSORIES

Banding coil or banding sleeve

NOTE

Banding coil or banding sleeve must be used for all sizes. Static wire must be properly imbedded during fitting installation and tested to assure proper static grounding of hose to a grounded system.

AVAILABLE SIZES

ID (inches)	OD (inches)	Pitch (inches)	Minimum Bend Radius (72°F, inches)	Working Pressure (72°F, PSI)	Vacuum Rating (72°F, In Hg)	Weight (Lbs/Ft)	Standard Length (Ft)
2	2.68	0.43	5.0	65	29.8	0.95	60,100
3	3.72	0.62	6.3	65	29.8	1.40	60,100
4	4.81	0.68	7.0	65	29.8	1.87	60,100

Over flexing or repeated flexing of hose within 18" of fitting is a common cause of hose failure. Installing a 12"-14" section of our Banding Coil at the end of the hose should be considered. *Kanaflex will not be responsible for damage to hose due to over flexing.*



flexFUEL™ 120 ST (ST 120 HP)

Heavy-duty tank truck drop hose

A lightweight and flexible solution. Featuring a nitrile rubber static dissipating tube and grounding wire for maximum static resistance. Perfect for gasoline gravity drops of naphtha, kerosene, oil, diesel, and ethanol blends with an external helix for easy handling.

FEATURES

Lightweight and flexible. Nitrile rubber static dissipating tube and static grounding wire provide maximum static resistance when connected to a grounded system. Construction makes it up to 50% lighter than the average rubber drop hose. External helix provides for easy drag. Rated for up to 40% aromatic content.

APPLICATIONS

Gasoline tank truck gravity drop hose for fluids such as naphtha, kerosene, light and heavy oil, diesel and some ethanol.

CONSTRUCTION

Nitrile rubber static dissipating tube, rigid PVC helix, synthetic braiding, smooth bore, static grounding wire, corrugated O.D.

TEMP. RANGE

-30°F to 140°F

ACCESSORIES

Banding coil or banding sleeve

NOTE

Banding sleeves or banding coils must be used for all sizes. Static wire must be properly imbedded during fitting installation and tested to assure proper static grounding of hose to a grounded system.

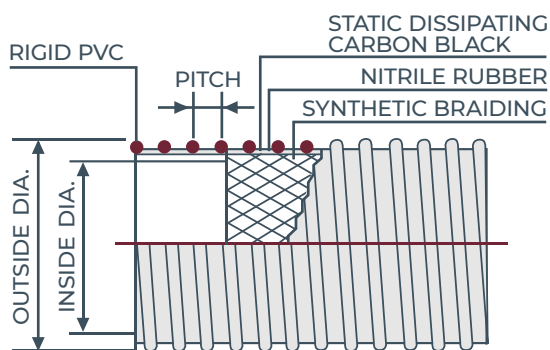

AVAILABLE SIZES

ID (inches)	OD (inches)	Pitch (inches)	Minimum Bend Radius (72°F, inches)	Working Pressure (72°F, PSI)	Vacuum Rating (72°F, In Hg)	Weight (Lbs/Ft)	Standard Length (Ft)
3	3.88	0.62	6.0	150	29.8	1.55	60,100
4	4.98	0.65	8.0	150	29.8	2.60	60,100

Over flexing or repeated flexing of hose within 18" of fitting is a common cause of hose failure. Installing a 12"-14" section of our Banding Coil at the end of the hose should be considered. *Kanaflex will not be responsible for damage to hose due to over flexing.*

|||| flexVAC™





flexVAC™ 180 AR (180 AR)

Heavy-duty abrasion resistant suction and discharge hose

A robust solution for demanding applications. Lightweight and flexible, the SBR rubber hose with static carbon black ensures exceptional abrasion resistance, static dissipation, and precise flow. Ideal for vacuum trucks handling crushed rock, sand, pea gravel, cement powder, dry fertilizer, iron ore, and grains.

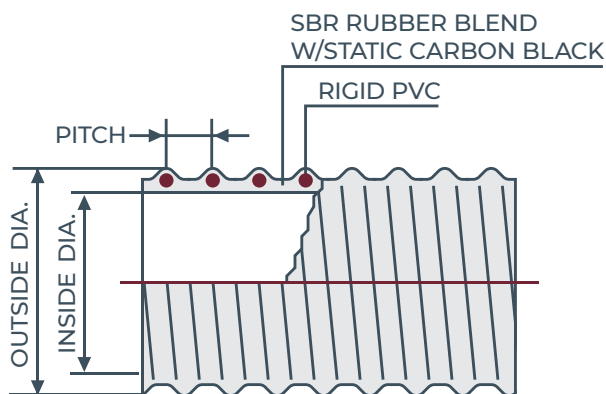

FEATURES

The lightweight and flexible SBR rubber hose blended with static carbon black makes it extremely abrasion resistant. Static dissipating with no grounding wire. The smooth bore allows for precise flow because no irregularities in the wall can cause interruptions. Smooth bore also promotes drainability.

APPLICATIONS

Heavy-duty abrasion resistant suction hose for vacuum trucks or handling abrasives such as crushed rock, sand, pea gravel, cement powder, dry fertilizer, iron ore and grains

TEMP. RANGE

-40°F to 140°F

CONSTRUCTION

SBR rubber blended with static carbon black, rigid PVC helix, smooth bore, corrugated O.D.

NOTE

This hose was not designed for bulk handling such as unloading of rail cars.

AVAILABLE SIZES

ID (inches)	OD (inches)	Pitch (inches)	Minimum Bend Radius (72°F, inches)	Working Pressure (72°F, PSI)	Vacuum Rating (72°F, In Hg)	Weight (Lbs/Ft)	Standard Length (Ft)
1-1/4	1.6	0.33	2.0	45	29.8	0.31	100
1-1/2	1.9	0.35	2.0	45	29.8	0.37	100
2	2.4	0.39	2.5	40	29.8	0.50	100
2-1/2	3.0	0.56	2.5	35	29.8	0.88	100
3	3.5	0.59	3.0	35	29.8	1.10	100
3-1/2	4.11	0.64	4.0	30	29.8	1.35	100
4	4.63	0.65	4.5	30	29.8	1.77	50,100
5	5.76	0.87	5.0	30	28.0	2.47	50,100
6	6.8	0.87	9.2	30	28.0	3.08	50,100
7	7.83	0.87	14.0	30	27.0	4.10	50
8	9.04	0.91	15.0	30	27.0	5.65	50
10	11.18	1.00	30.0	28	25.0	8.88	20
12	13.31	1.18	40.0	25	25.0	10.43	20

Over flexing or repeated flexing of hose within 18" of fitting is a common cause of hose failure. Installing a 12"-14" section of our Banding Coil at the end of the hose should be considered. Kanaflex will not be responsible for damage to hose due to over flexing.



flexVAC™ 180 HR (180 HR)

High temperature abrasion resistant suction hose

An ideal solution for heavy-duty suction applications in high-temperature and abrasive environments. Lightweight, flexible, and designed to withstand temperatures up to 220°F, it ensures efficient material handling of fly ash, crushed rock, sand, pea gravel, or cement powder.

FEATURES

Lightweight and flexible suction hose designed to sustain temperatures up to 220°F. Integral wire helix can be grounded. External helix provides easy drag. The smooth bore allows for precise flow because no irregularities in the wall can cause interruptions.

APPLICATIONS

Heavy-duty suction applications where high temperature and abrasion are factors such as vacuum trucks or the handling of fly ash, crushed rock, sand, pea gravel or cement powder

CONSTRUCTION

EPDM rubber, polyethylene helix, metal helical wire, smooth bore, corrugated O.D.

TEMP. RANGE

-40°F to 220°F

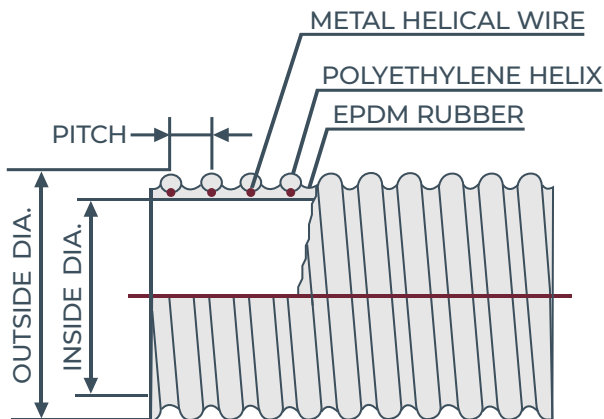

AVAILABLE SIZES

ID (inches)	OD (inches)	Pitch (inches)	Minimum Bend Radius (72°F, inches)	Working Pressure (72°F, PSI)	Vacuum Rating (72°F, In Hg)	Weight (Lbs/Ft)	Standard Length (Ft)
4	4.69	0.65	5.5	30	29.8	1.75	50,100
5	6.92	0.86	9.0	30	29.0	3.06	50,100
6	6.90	0.83	9.8	30	28.0	3.46	50,100
8	9.13	0.83	15.0	30	27.0	6.00	50

Over flexing or repeated flexing of hose within 18" of fitting is a common cause of hose failure. Installing a 12"-14" section of our Banding Coil at the end of the hose should be considered. *Kanaflex will not be responsible for damage to hose due to over flexing.*



flexVAC™ 180 STAR (180 STAR)

Heavy-duty abrasion resistant suction and discharge hose

A robust solution for demanding applications. Lightweight and flexible, the SBR rubber hose with static carbon black and a grounding wire ensures maximum static resistance. Ideal for vacuum trucks handling abrasives like crushed rock, sand, pea gravel, cement powder, dry fertilizer, iron ore, and grains.

FEATURES

The lightweight and flexible SBR rubber hose blended with static carbon black and a static grounding wire provide maximum static resistance when connected to a grounded system. The smooth bore allows for precise flow because no irregularities in the wall can cause interruptions. External helix provides easy drag.

APPLICATIONS

Heavy-duty abrasion resistant suction hose for vacuum trucks or handling abrasives such as crushed rock, sand, pea gravel, cement powder, dry fertilizer, iron ore and grains.

TEMP. RANGE

-40°F to 140°F

CONSTRUCTION

SBR rubber blended with static carbon black, rigid PVC helix, smooth bore, with copper wire, corrugated O.D.

NOTE

This hose was not designed for bulk handling such as unloading of rail cars.

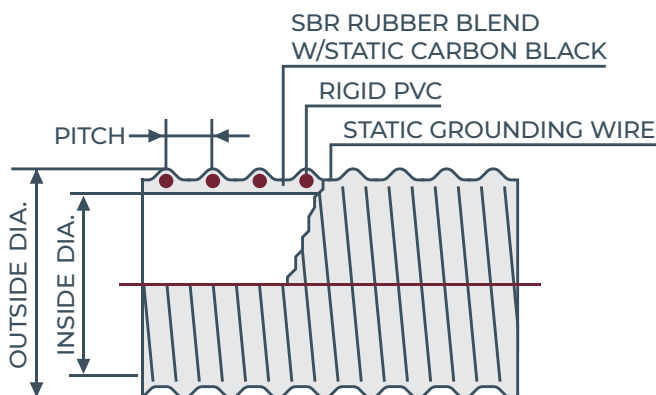

AVAILABLE SIZES

ID (inches)	OD (inches)	Pitch (inches)	Minimum Bend Radius (72°F, inches)	Working Pressure (72°F, PSI)	Vacuum Rating (72°F, In Hg)	Weight (Lbs/Ft)	Standard Length (Ft)
1-1/2	1.90	0.35	2.5	45	29.8	0.50	100
2	2.44	0.39	2.5	40	29.8	0.60	100
3	3.50	0.59	3.0	35	29.8	1.19	100
4	4.63	0.65	4.5	30	29.8	1.84	50, 100
6	6.80	0.87	9.2	30	28.0	3.26	50, 100

Over flexing or repeated flexing of hose within 18" of fitting is a common cause of hose failure. Installing a 12"-14" section of our Banding Coil at the end of the hose should be considered. *Kanaflex will not be responsible for damage to hose due to over flexing.*



flexVAC™ lite 180 AR (180 BL)

Lightweight abrasion resistant blower and suction hose

A versatile solution for suction and light blowing of lightweight abrasives. Its SBR rubber blend with static carbon black ensures exceptional abrasion resistance and static dissipation. Ideal for materials like rockwool, fiberglass, sawdust, grain, insulation, and cement dust.

FEATURES

The lightweight and flexible SBR rubber hose blended with static carbon black makes it extremely abrasion resistant. Static dissipating with no grounding wire. The smooth bore allows for precise flow because no irregularities in the wall can cause interruptions.

APPLICATIONS

Designed for suction and light blowing of lightweight abrasives such as rockwool, fiberglass, sawdust, grain, insulation and cement dust.

TEMP. RANGE

-40°F to 140°F

CONSTRUCTION

SBR rubber blended with static carbon black, rigid PVC helix, smooth bore, corrugated O.D.

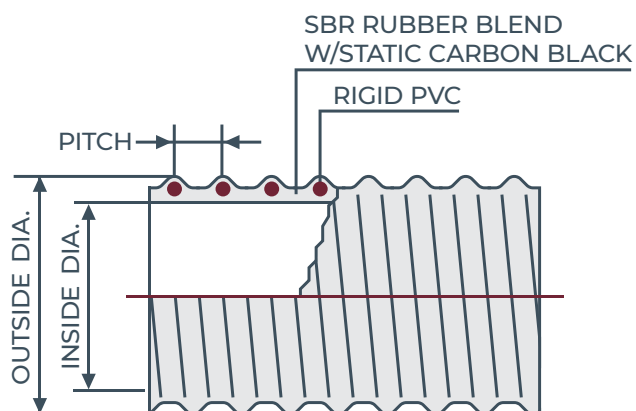

AVAILABLE SIZES

ID (inches)	OD (inches)	Pitch (inches)	Minimum Bend Radius (72°F, inches)	Working Pressure (72°F, PSI)	Vacuum Rating (72°F, In Hg)	Weight (Lbs/Ft)	Standard Length (Ft)
2-1/2	2.91	0.56	2.5	18	25.0	0.71	100
3	3.44	0.59	3.0	13	23.0	0.92	100
4	4.53	0.65	4.0	10	20.0	1.50	50,100
5	5.63	0.87	5.0	8	15.0	1.68	50,100
6	6.67	0.87	9.0	8	15.0	2.40	50,100
7	8.71	0.87	10.0	8	15.0	3.00	50
8	8.98	0.91	12.0	8	15.0	4.40	50

Over flexing or repeated flexing of hose within 18" of fitting is a common cause of hose failure. Installing a 12"-14" section of our Banding Coil at the end of the hose should be considered. Kanaflex will not be responsible for damage to hose due to over flexing.



flexVAC™ lite 180 MVAR (180 MV)

Medium-duty abrasion resistant suction and discharge hose

A versatile solution for various applications. Lightweight and flexible, the SBR rubber hose with static carbon black ensures exceptional abrasion resistance and static dissipation. Perfect for grain and roof vacuums, featuring an external helix for easy drag and a smooth bore for precise flow.

FEATURES

The lightweight and flexible SBR rubber hose blended with static carbon black makes it extremely abrasion resistant. Static dissipating with no grounding wire. External helix provides easy drag. The smooth bore allows for precise flow because no irregularities in the wall can cause interruptions.

APPLICATIONS

Designed for numerous applications such as grain and roof vacuums.

TEMP. RANGE

-40°F to 140°F

CONSTRUCTION

SBR rubber with carbon black, rigid PVC helix, smooth bore, corrugated O.D.

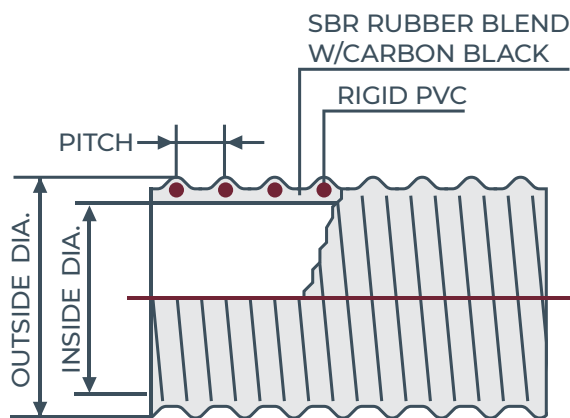

AVAILABLE SIZES

ID (inches)	OD (inches)	Pitch (inches)	Minimum Bend Radius (72°F, inches)	Working Pressure (72°F, PSI)	Vacuum Rating (72°F, In Hg)	Weight (Lbs/Ft)	Standard Length (Ft)
5	5.75	0.87	5.0	8	18.0	2.00	50, 100
6	6.73	0.87	9.0	8	18.0	2.70	50, 100

Over flexing or repeated flexing of hose within 18" of fitting is a common cause of hose failure. Installing a 12"-14" section of our Banding Coil at the end of the hose should be considered. *Kanaflex will not be responsible for damage to hose due to over flexing.*



flexVAC™ lite U Boom ST (KB LITE ST)

Medium-duty wet & dry material remote hose with grounding wire

Ideal for diverse applications. Lightweight, flexible, and abrasion-resistant, with a static copper wire for dissipating charges. Suitable for hydro-vac trucks, vacuum trucks, general construction with rock, gravel, sand, and crushed concrete, as well as industrial vac equipment, roof vac, dry fertilizer, and petcoke.

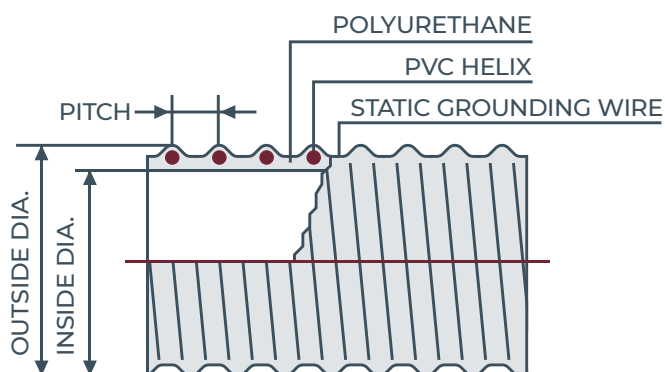

FEATURES

Lightweight and flexible in sub-zero temperatures. Abrasive resistant polyurethane tube provides increased lifetime, prevents material build-up and provides quiet operation. Static copper wire in construction dissipates static charge when connected to a grounded system. External helix provides for easy drag.

APPLICATIONS

Hydro-vac truck, vacuum truck, general construction use, such as rock, gravel, sand and crushed concrete. Industrial vac equipment, roof vac, dry fertilizer and petcoke.

CONSTRUCTION

Flexible abrasion polyurethane liner, rigid PVC helix, smooth bore, PVC corrugated O.D. with static dissipating materials and grounding wire.

TEMP. RANGE

-40°F to 140°F

ACCESSORIES

Banding coil or Powerlock Clamp must be used for all sizes

NOTE

Not a food-grade hose

AVAILABLE SIZES

ID (inches)	OD (inches)	Pitch (inches)	Minimum Bend Radius (72°F, inches)	Working Pressure (72°F, PSI)	Vacuum Rating (72°F, in Hg)	Weight (Lbs/Ft)	Standard Length (Ft)
1 1/2	1.81	0.35	2.0	35	29.0	0.39	100
2	2.36	0.39	2.5	27	29.0	0.55	100
2 1/2	2.93	0.53	4.5	27	29.8	0.75	100
3	3.50	0.59	5.5	25	29.0	1.10	60, 100
4	4.55	0.65	6.5	20	28.0	1.60	50, 100
5	5.73	0.83	11.0	20	28.0	2.75	50, 100
6	6.73	0.83	11.0	20	28.0	3.80	50, 100
8	9.04	0.91	16.0	20	27.0	5.38	50

Over flexing or repeated flexing of hose within 18" of fitting is a common cause of hose failure. Installing a 12"-14" section of our Banding Coil at the end of the hose should be considered. *Kanaflex will not be responsible for damage to hose due to over flexing.*



flexVAC™ Max (Kanapower AT)

Heavy-duty high pressure suction and discharge hose

Crafted for demanding applications like slurry in micro-tunneling and directional boring. Its SBR rubber blend with static carbon black ensures exceptional abrasion resistance and static dissipation.

FEATURES

The lightweight and flexible SBR rubber hose blended with static carbon black makes it extremely abrasion resistant. Static dissipating with no grounding wire. The synthetic braiding gives the hose increased flexibility and durability. External helix provides easy drag. The smooth bore allows for precise flow because no irregularities in the wall can cause interruptions.

APPLICATIONS

Abrasion resistant suction and discharge hose designed for demanding applications such as slurry in micro-tunneling applications and directional boring.

TEMP. RANGE

Range: -30°F to 140°F

CONSTRUCTION

SBR rubber blended with static carbon black, rigid PVC helix, smooth bore, synthetic braid, corrugated O.D.

NOTE

6" size is not a stock item. Consult factory for availability.

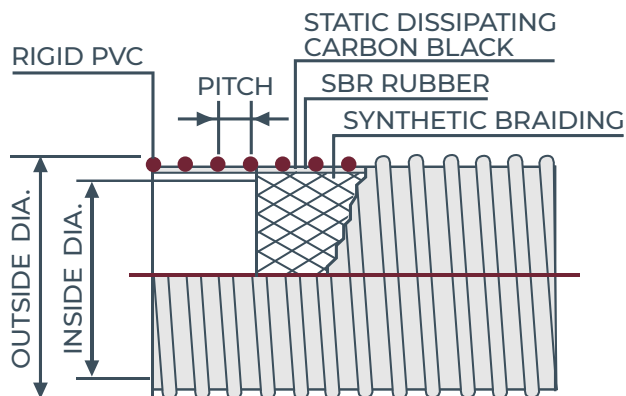

AVAILABLE SIZES

ID (inches)	OD (inches)	Pitch (inches)	Minimum Bend Radius (72°F, inches)	Working Pressure (72°F, PSI)	Vacuum Rating (72°F, In Hg)	Weight (Lbs/Ft)	Standard Length (Ft)
4	5.28	0.65	10.0	140	28.0	2.85	60,100
6	7.36	0.87	16.0	140	28.0	4.50	Not stock item

Over flexing or repeated flexing of hose within 18" of fitting is a common cause of hose failure. Installing a 12"-14" section of our Banding Coil at the end of the hose should be considered. *Kanaflex will not be responsible for damage to hose due to over flexing.*

Kanaflex®

The Original Flexible Hose



flexVAC™ U Boom ST (STKB)

Heavy-duty abrasion resistant wet and dry material handling hose

A reliable choice for diverse applications. Lightweight and flexible in sub-zero temperatures, featuring an abrasive-resistant polyurethane tube for extended lifetime and quiet operation. Ideal for hydro-vac trucks, vacuum trucks, general construction, and wet and dry applications, with a full vacuum rating.

FEATURES

Lightweight and flexible in sub-zero temperatures. Abrasive resistant polyurethane tube provides increased lifetime, prevents material build-up and provides quiet operation. Static copper wire in construction dissipates static charge when connected to a grounded system. External helix provides for easy drag.

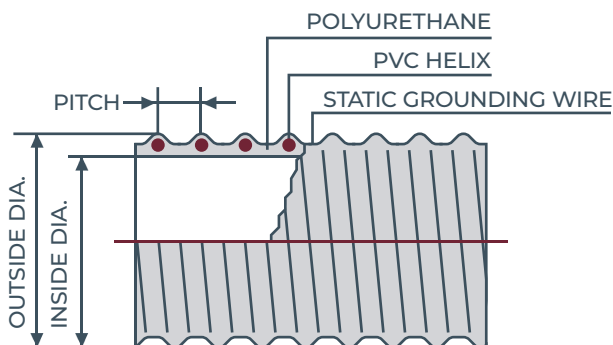

APPLICATIONS

Hydro-vac truck, vacuum truck, general construction use, wet and dry full vacuum rated.

CONSTRUCTION

Flexible high abrasion polyurethane liner, rigid PVC helix, no direction required, smooth bore, extra UV inhabitant PVC corrugated O.D. with static dissipating materials and grounding wire.

TEMP. RANGE

-40°F to 140°F

ACCESSORIES

Banding coil or Powerlock Clamp must be used for all sizes. Static wire must be properly embedded during fitting installation and tested to assure proper static grounding of hose to a grounded system.

NOTE

Not a food-grade hose

AVAILABLE SIZES

ID (inches)	OD (inches)	Pitch (inches)	Minimum Bend Radius (72°F, inches)	Working Pressure (72°F, PSI)	Vacuum Rating (72°F, In Hg)	Weight (Lbs/Ft)	Standard Length (Ft)
4	4.86	0.60	6.5	20	29.8	2.0	60,100
6	7.37	0.83	11.0	20	28.0	3.9	60,100
8	9.21	0.85	18.0	20	28.0	6.6	40

Over flexing or repeated flexing of hose within 18" of fitting is a common cause of hose failure. Installing a 12"-14" section of our Banding Coil at the end of the hose should be considered. *Kanaflex will not be responsible for damage to hose due to over flexing.*

|||| flex**VAPOR**™





flexVAPOR™ 120 ST (ST120 VP)

Gasoline vapor recovery hose

A specialized solution for vapor recovery. Featuring a nitrile rubber static dissipating tube, grounding wire, and smooth bore for precise flow. External helix ensures easy drag.

FEATURES

Nitrile rubber static dissipating tube and static grounding wire provide maximum static resistance when connected to a grounded system. The smooth bore allows for precise flow because no irregularities in the wall can cause interruptions. External helix provides easy drag.

APPLICATIONS

Gasoline vapor recovery hose only

CONSTRUCTION

Nitrile rubber, rigid PVC helix, smooth bore, corrugated O.D., static grounding wire

TEMP. RANGE

-40°F to 140°F

NOTE

Static wire must be properly imbedded during fitting installation and tested to assure proper static grounding of hose to a grounded system.

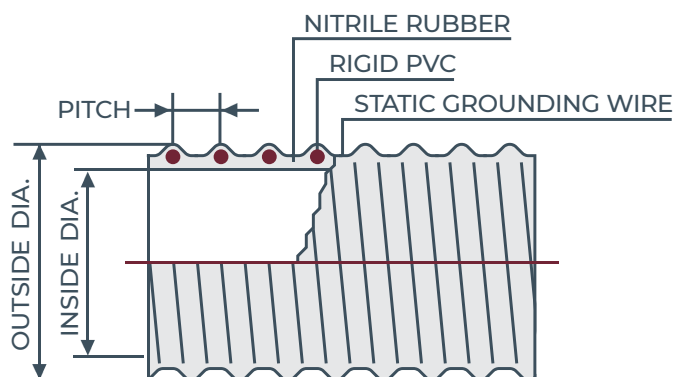

AVAILABLE SIZES

ID (inches)	OD (inches)	Pitch (inches)	Minimum Bend Radius (72°F, inches)	Working Pressure (72°F, PSI)	Vacuum Rating (72°F, in Hg)	Weight (Lbs/Ft)	Standard Length (Ft)
2	2.36	0.39	3.0	20	29.8	0.61	60,100
3	3.46	0.59	3.5	10	29.8	1.00	60,100
4	4.57	0.65	5.0	10	29.8	1.70	60,100

Over flexing or repeated flexing of hose within 18" of fitting is a common cause of hose failure. Installing a 12"-14" section of our Banding Coil at the end of the hose should be considered. *Kanaflex will not be responsible for damage to hose due to over flexing.*



flexVAPOR™ U 120 ST (ST 120 UACVR)

All purpose tank truck and terminal vapor recovery hose

An adaptable solution for various fuels. Lightweight and flexible, constructed with polyurethane for use with gasoline blends, biodiesel, ethanol, kerosene, diesel, and ASTM fuel oils. Featuring a static dissipating tube and multi-strand copper static wire for ultimate protection against static discharge.

FEATURES

Lightweight and flexible even in sub-zero temperatures. Polyurethane construction allows use with all gasoline blends, biodiesel (up to B100), ethanol (up to E85; currently testing E100), kerosene, diesel, and ASTM fuel oils. Static dissipating tube combined with multi-strand copper static wire provides the ultimate protection against static discharge. Clear tube allows visual confirmation of fuel backup into the hose.

APPLICATIONS

Tank truck and terminal recovery of gasoline, ethanol, and biodiesel vapors.

CONSTRUCTION

Lightweight clear static dissipating non-permeable polyurethane with smooth bore, corrugated O.D., rigid PVC helix, and static grounding wire.

TEMP. RANGE

-52°F to 140°F

ACCESSORIES

Banding sleeve or banding coil

NOTE

Banding sleeve or banding coil must be used. Static wire must be properly imbedded during fitting installation and tested to assure proper static grounding of hose to a grounded system.

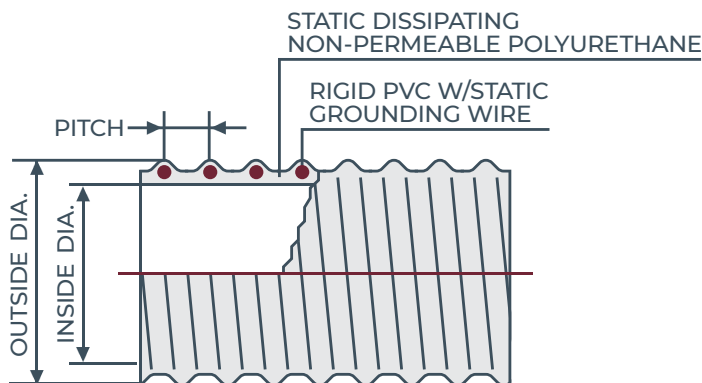

AVAILABLE SIZES

ID (inches)	OD (inches)	Pitch (inches)	Minimum Bend Radius (72°F, inches)	Working Pressure (72°F, PSI)	Vacuum Rating (72°F, In Hg)	Weight (Lbs/Ft)	Standard Length (Ft)
2	2.38	0.39	2.0	9	16.0	0.44	60,100
3	3.56	0.57	3.0	8	15.0	0.71	60,100
4	4.57	0.65	4.0	7	13.0	0.98	60,100

Over flexing or repeated flexing of hose within 18" of fitting is a common cause of hose failure. Installing a 12"-14" section of our Banding Coil at the end of the hose should be considered. *Kanaflex will not be responsible for damage to hose due to over flexing.*



flexVAPOR™ lite U 101 (101 PS UVOR)

General vapor, water suction and discharge hose

An adaptable solution for diverse applications. Constructed with flexible PVC, it ensures durability with solid wall construction and UV inhibitors. Ideal for methane gas recovery at landfills, connecting rigid pipes, and repairing broken lines.

FEATURES

Lightweight and flexible hose constructed with flexible PVC. The solid wall construction and extra UV inhibitors provide increased durability. External helix provides for easy drag. Rated for both suction and discharge. The smooth bore allows for precise flow because no irregularities in the wall can cause interruptions. Smooth bore also promotes drainability.

APPLICATIONS

General vapor hose with solid wall construction and UV inhibitors make it perfect for methane gas recovery at landfills. It can also be used in the connection of rigid pipes of the same size, and the repair of broken rigid lines.

CONSTRUCTION

Flexible PVC, rigid PVC helix, smooth bore, corrugated O.D.

TEMP. RANGE

-13°F to 140°F

NOTE

Not a food-grade hose

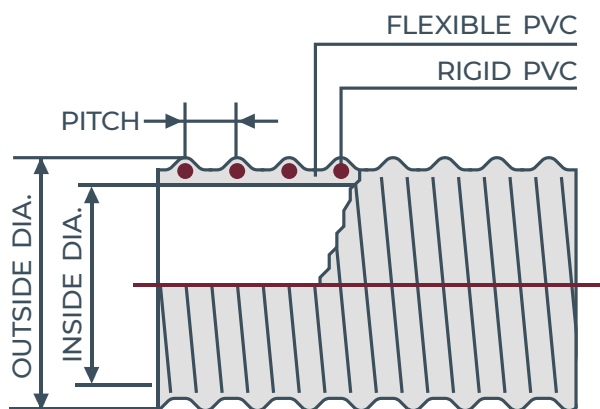

AVAILABLE SIZES

ID (inches)	OD (inches)	Pitch (inches)	Minimum Bend Radius (72°F, inches)	Working Pressure (72°F, PSI)	Vacuum Rating (72°F, in Hg)	Weight (Lbs/Ft)	Standard Length (Ft)
2.375	2.76	0.41	3.5	35	29.8	0.64	100
3-1/2	4.02	0.63	7.0	30	29.8	1.10	100
4-1/2	5.08	0.67	9.0	30	28.0	1.70	100

Over flexing or repeated flexing of hose within 18" of fitting is a common cause of hose failure. Installing a 12"-14" section of our Banding Coil at the end of the hose should be considered. *Kanaflex will not be responsible for damage to hose due to over flexing.*

Accessories



Banding Sleeve

Plastic banding sleeve for use with ST 120 LT hose

APPLICATIONS

9" sections are recommended at each end of the ST 120 LT tank truck drop hose.

CONSTRUCTION

PVC construction, corrugated inside, smooth O.D.

TEMP. RANGE

-40°F to 140°F

AVAILABLE SIZES

3" and 4". Standard length: 3 ft.



Banding Coil (Black or White)

Black or white PVC banding coil available in 1-1/2", 2", 3", 4", 5", 6", 8", 10", and 12" sizes

APPLICATIONS

PVC Banding Coil designed to fit and fill the area between the helix providing a smooth service for installation of tension bands. Use 4" of banding coil to cover 9" length of the hose. Also, when used behind the coupling, the coil adds rigidity

to the hose, preventing over flexing at the coupling. Coil can be installed on individual hoses as noted.

AVAILABLE SIZES

Standard length: 1 ft.



Clamps

DUCT CLAMP

Steel, worm gear type clamp designed specifically for use with our duct hose. Easily installed with only a screw driver.

AVAILABLE SIZES

2-1/2", 3", 4", 5", 6", 7", 8", 10" and 12"



POWERLOCK CLAMP POWERLOCK CLAMP PS

The Powerlock clamp is a steel, double bolt clamp designed specifically for use with our corrugated hoses.

AVAILABLE SIZES

2", 2-1/2", 3", 4", 5", 6", 8", 10" and 12"

The Powerlock clamp PS is available for use with our 101 PS Series in 2", 3" and 4" sizes.



TIGHTENING KANAFLEX POWERLOCK CLAMPS

Please use the table below to determine the correct torque recommended when tightening down our Powerlock clamps.

Size (in)	2	2-1/2	3	4	5	6	8	10	12
Torque (lbs-ft)	7.2	7.2	9.4	14.5	14.5	16.6	16.6	18.1	18.1

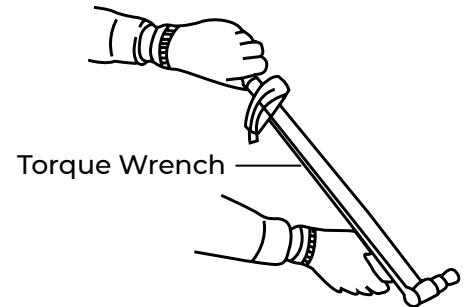



HEADQUARTERS
800 Woodlands Parkway
Vernon Hills, IL 60061
847.634.6100
FAX: 847.634.6249

PIPE PLANT
875 Woodlands Pkwy
Vernon Hills, IL 60061
847.276.2235

WAREHOUSE
9819 Wallisville Road
Houston, TX 77013

kanaflex.com

The applications presented in this document are described with the sole purpose of allowing the readers to make their own evaluations and decisions. Kanaflex makes no guarantees nor warranties of suitability for any application. It is the responsibility of the project's design engineer to ensure that all selected materials for the project are fit for the specific application. Kanaflex makes no warranty whatsoever, express, or implied, related to the applications, materials, coatings, or products discussed herein.